



201919094308



中国认可
国际互认
检测
TESTING
CNAS L12422

型式试验报告

Type Test Report

报告编号: P200628315

产品名称 : 电涌保护器

Sample Name

型号规格 : TGE-SPD40K 385C/4

Model No.

受检单位 : 西安天工电气有限公司

Applicant

签发日期 : 2020年7月6日

Issue Date



广东雷宁普电气检测技术有限公司
Guangdong LNP Electronical Testing Technology Co., Ltd.

:š 6

(l -ç>?0í @š -çDÉäCø .L Cç??^ D

(l -ç>?0í)C :” /, 7>DÝ9-8ÊD->??^ D

> 2 ; @š;J 6 7>DÝÍ) +d• D' É9œ%• D'* =f Ê(_(l -ç D

(l -ç= ` -¥>??^ D

> =ç0í)C1-5 (\)C@š <)C? 6)C;5 1, .œ> BÑD

> 0´-” DêD-ø°, (ç D +e(l -ç Í) 2@ñ5: ^ 0 +eD 6 E AäD

9Q5 0í @š -ç)÷AñAMJÍ AÇû6+^(l -çD 9¶8Q >F9¶6»? 0í

@šF> <Â* Í B 8;) B *‡3Î ÉA5Aěç9¶8; 0 4•9, (l -ç8Ê6 9¶

8;> DÝÊ D

(_0 .Z=I @Dêp

+F> +yD Û, IY;1; 4>C”>#9<6°5 V Aá 2ç0•B’ % /&

Aë (• Û

+^ /Ñ Û

*œ C‡Û

=™ C_Û ZZZ @SMWFRP



检验检测机构 资质认定证书

证书编号：201919094308

名称：广东雷宁普电气检测技术有限公司

地址：东莞市石龙镇新维村温泉南路70号鑫永盛科技园B栋101号

经审查，你机构已具备国家有关法律、行政法规规定的基本条件和能力，现予批准，可以向社会出具具有证明作用的数据和结果，特发此证。
资质认定包括检验检测机构计量认证。

检验检测能力及授权签字人见证书附表

你机构对外出具检验检测报告或证书的法律责任由广东雷宁普电气检测技术有限公司承担。

许可使用标志



201919094308

注：需要延续证书有效期的，应当在证书届满有效期3个月前提出申请，不再另行通知。

本证书由国家认证认可监督管理委员会监制，在中华人民共和国境内有效。

发证日期：2019年04月17日

有效期至：2025年04月16日

发证机关：(印章)



首次



中国合格评定国家认可委员会 实验室认可证书

(注册号: CNAS L12422)

兹证明:

广东雷宁普电气检测技术有限公司

(法人: 广东雷宁普电气检测技术有限公司)

**广东省东莞市石龙镇新维村温泉南路 70 号鑫永盛科技园 B
栋 101 号, 523000**

符合 ISO/IEC 17025: 2017 《检测和校准实验室能力的通用要求》
(CNAS-CL01 《检测和校准实验室能力认可准则》) 的要求, 具备承担本
证书附件所列服务能力, 予以认可。

获认可的能力范围见标有相同认可注册号的证书附件, 证书附件是
本证书组成部分。

生效日期: 2019-07-12

截止日期: 2025-07-11



中国合格评定国家认可委员会授权人

中国合格评定国家认可委员会 (CNAS) 经国家认证认可监督管理委员会 (CNCA) 授权, 负责实施合格评定国家认可制度。
CNAS 是国际实验室认可合作组织 (ILAC) 和亚太实验室认可合作组织 (APLAC) 的互认协议成员。
本证书的有效性可登陆 www.cnas.org.cn 获认可的机构名录查询。

网上查询说明

尊敬的客户：

为了方便您推广、更方便您查询，欢迎使用我司查询服务。

1. 网站查询：登陆网址 <http://www.lnptest.com>,在“客户服务-证书及报告查询”栏中输入报告编号，即可查询到所需报告的公开信息。

证书及报告查询

通过输入证书编号可以查询该产品防雷产品认证证书。

请输入证书编号



立即查询 →

2. 扫描下方二维码查询，更加方便快捷。



广东雷宁普电气检测技术有限公司

咨询电话：0769-81329986



型式试验报告

样品名称: 电涌保护器

型号: TGE-SPD40K 385C/4

品牌: **TGE**

数量: 18 个

样品状态: 外观功能完好

接收日期: 2020 年 6 月 27 日

开始日期: 2020 年 6 月 28 日

完成日期: 2020 年 7 月 8 日

申请人: 西安天工电气有限公司

申请人地址: 陕西省西咸新区沣东新城和平工业园红光路 53 号

制造商: 西安天工电气有限公司

制造商地址: 陕西省西咸新区沣东新城和平工业园红光路 53 号

生产厂: 西安天工电气有限公司

生产厂地址: 陕西省西咸新区沣东新城和平工业园红光路 53 号

试验依据标准:

GB/T 18802.1-2011 低压电涌保护器(SPD)

第 1 部分: 低压配电系统的电涌保护器——性能要求和试验方法

试验结论:

该产品符合标准要求, 所检项目测试合格。

检测人: 陈国相

签名:  日期: 2020-7-8

审核人: 童礼发

签名:  日期: 2020-7-8

批准人: 张涛

签名:  日期: 2020-7-8



广东雷宁普电气检测技术有限公司

2020 年 7 月 8 日

备注: 下次监督日期为 2022 年 7 月 7 日

)[8 .Z)ê0' 1, .Z<1+,

1, .Z-: A ;Ö6 Û -) [8 > +n@Z..+^>Ö-T+e^AăD/Ă8XÍ 5à-x6,,3 +e>ÿ@ZG6'B'0BAêA 8 1';U@/Đ
>P@Z +^E E)ê D6,,3 :pAñA -x,! 4G+e-r3ì8XÍ =r3ì8X+e.EE BŽÍ> 9@r2üÍ -) .G6½=I.ž +r># 1t
+,,9»/Đ=r3ì8X3ÜA+Pê +P4G E 3•; >÷D+R=r3ì8X E /T Í +^AăD/Ă8XCž =Y6 ;4*' 1L>ă, /M:LD
; _ D

[8 ?@&0' 6)ç Û 7* (63' . & Í +^AăD/Ă8X

63' +e,÷3ÁÛ

D 63' +e,, 2û:^ Û A ,, 2û Ü □ ,,, 2û

E 63' +e:%0\$3Á?@Û +^@ZÿD'@Û +^@Zÿy ?@Û -• /0 ?@

F 63' +e;5 @ŠÁ' Û ,3Á5 @ŠÛ ,,3Á5 @ŠÛ ,,3Á5 @Š

G 63' +e; Aă+y,, Û /È6» Ü /È=f

H 63' +eA8†0' ?µ Û A8†0' +eÜ) A8†0' +e

I 63' +e" DÑ; Û .m, +eÜ A', +e

J 63' +e(D/Ă.G6½Û 9@D/Ă Ü ?š5 +^4~(D/Ă Ü .ž 4~(D/Ă

K 63' +e-r3ì8XÛ 6» +eÜ =f) +eÜ ,_C€ Añ

L 63' ;(- > ,A0—63' Û ;(Ü - ÉE /0,p; > ,3+e)[8 > ,è,A0—63' É

)[8 +eD)A E)ê) 0B

D 1t? ,, DôÛ 5>, ?@Û >?5>, ?@Û 2YB-*Š*- Ü 5>6™C)F=XC)FE

2ê0±1•+]? 3Á?@' 8EE ?,./ E *Ô1y6 0 Û ,A.j AĐ+]? P P P P

9É(5>, ?@Í 8E()ç 5>>' D 2 Û P P

E 2è<Æ 0 E

=f2è)%4p6)ç 0' 7g& Û 3%7

0 E)%4p6)ç 0' 7g& Û 3%7

F >ÿ@B'0BÛ @Z +^E

G 1t? ,, DôÛ =N

H =r3ì8XD1A8½4';U Û +r># >^

I =r3ì-ÿ Û =N

=]D (• /&

D DÿDÑ.=](• /& Û

E +^8YBŽÍ=](• /& Û

0•;V)/ ;^

,÷? 6)/ ;^

,O, .EE +^ @Z8 Û _____ 9DF

E *Ö)÷? ÛB-?±+^ @Z& Û _____ 9DF _____ É5àD7D/Á6,,; AñA -x+^ @D È

5àD7D/Á6,,; +e;5 @ŠÁ(/ . ,æ+^)/ ;^ Û

,3Á5 @Š[7] È _{IP S} Û _____

,,3Á5 @Š[7] È _{P DI} Û _____ N\$ _____

,,3Á5 @Š[7] È _{RF} Û _____

,3Á. ,,3Á+e()ç,æ+^+^4~ _Q Û _____ N\$ _____ É5àD7D/Á6,,; AñA -x+^4~D È

+^ @D/Á;ï 8 _S Û _____ NØ _____ É5àD7D/Á6,,; AñA -x+^ @D È

, - 5 +^4~6@=6¼GÛ _____ \$ _____

Dý,æ+^+^4~ _{MRVD} Û _____

+^4~3Á?@Û _____ 1\4~ _____

? ;^ Û _____ 9B? _____

,3,á/Á+i0-Û _____ ,3 _____

,O, ,02Ë?Ù4~D Û _____ É1-;+ AäAÛ+^ @ZËy B<0B È

,O, -> B^+4~ Û _____ É1-;+ AäAÛ_ ,, 2Û. ;E9ì ;E* ,÷2Ë+eA ,, 2Û 63' È

-> B^A+^ Aä@=6¼GÛ _____ É1-;+ AäAÛ_ ,, 2Û. ;E9ì ;E* ,÷2Ë+eA ,, 2Û 63' È

-> B^A, - 5 6@=6¼GÛ _____ É1-;+ AäAÛ_ ,, 2Û. ;E9ì ;E* ,÷2Ë+eA ,, 2Û 63' È

+^ @ZVÛ _____ É1-;+ AäAÛ_ ,, 2Û. ;E9ì ;E* ,÷2Ë+eA ,, 2Û 63' È

; Aä,,; Û _____ 71 >Ö-T _____

B¾•.ž+^ @Ž 72 9È<1?µÛ

D B»ÀD1@ZÖ-T+ek CpA^8Q+eB¾ .ž+^ @Ž 72 9È>ã;5 @Š

72 9.k Cp6,,; Ü 72 96@= <1?µÜ☒) ;+Aä

E B»n@ZÖ-T.k CpA^8Q+eB¾ .ž+^ @Ž 72 9È>ã;5 @Š

72 9.k Cp6,,; Ü ☒ 72 96@= <1?µÜ☐) ;+Aä

>#,) ,x> Û _____ ‡D" ‡ _____

=r3ì, E D; É9ÈœAñ+eÑ È Û /M:L>; ?^ í (:LCžÄ _____

=f) 63' =r3ì 8X+e0•;VA 9 Û _____

1-AäAÛ ,3Á5 @Še(i 6¼` Û _____

@š8 6 ;W 0' ;Ö 6

DЖ)/ ;^ -ž (Ž É9 =M ; AăŽ-ò? ; (Ž; í ,AB (Ž-ò: _* Ê
„3Á5 @Š 7 Ê Û

?@&	(D/Á6,,;	P D[É N\$ Ê	Q É N\$ Ê	Œ É 9 Ê	Œ É N\$ Ê	E /0 ,P;
7* (63' . &	/ 1 3(3



?@&1f,.

7* (63' . &

7* (Û8 7g6)ç< ?•

ÛE *Ô=14~ PDI N\$

ÛE *Ô)÷?ÛEE +^ @Z 9\$&

Û 3E /0,P;

<1;C1,.Z;Ö6 É9ËAñ?ÉA Ê

>?

) [8 9°D 9 3

>?

“ 90BBA 3i(Ž

?Ó&	“ 90BBA)ç	.y 0Ý4,,) 0B B(8X0B)%4p 6)ç	?@&
	=f2è	;ý 4p	3%7
	1t? ,, Dô	=N	
	>ÿ@B(0B	@B +^ E	
	=r3ì 8XD1A89¼' ;U	+n># >^;à	
	=r3ì ->	=N	

DÃÛ+R“ 90BBA+e.y 0Ý4,,) 0B B(8X0B)%4p >ÿAÛA -x D' BÍ:m CA -x?@&A50' A <,0•;V)/ ;^; Í AÇ-R
D9•)C;5 < Añ? .y ? 6 D

@š8 6 ;W0' ;Ö 6

) [8 =f?~ C8

Ê=f?~

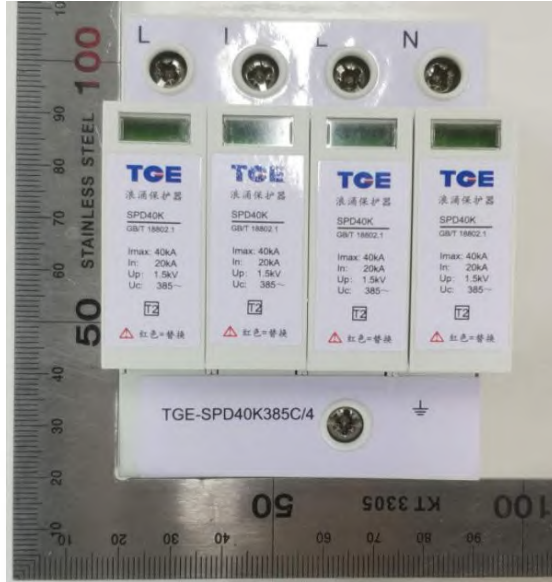

Ê6 7g

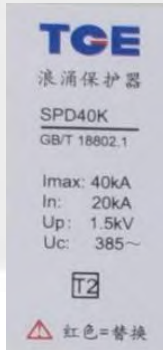

0í @š 6 0 DýŽ

?Ó&	0í @š? 6	A!2>(DÝÖ	@š (• /&	0í @š, .œ
,	(; /.(D			/0-Ò
	1t? ,, Dš. 4Mt			/0-Ò
	,áD 1t1t*†;5 @Š) ;+Aä
	*p0 .G/%.)14~			/0-Ò
„	(D/Á;ĭ 8		í í	/0-Ò
„„	, E -> B¹;5 @Š		í í	/0-Ò
,9	,0- /: „0-Đý;æ+^ 4~) ;+Aä
9	9⊕), ?µ;5 @Š		í í	/0-Ò
9,	, - 5 +^ 4~6⊕=6¼G		í í	/0-Ò
9,,	72 9;5 @Š) ;+Aä
	72 9;5 @Š) ;+Aä
9,,,	9Í +^ 3£/. +^? 8E4Mt) ;+Aä
	0 ?-8à.)			/0-Ò
	0 ?-8à.)) ;+Aä
	2YB+^E			/0-Ò
	1Š+^8à.)			/0-Ò
	/Ø2 C,3*Ů5L			/0-Ò
	6⊕⊕5 @Š			/0-Ò
	+^8Y0Á>×. 7a+^2A3ĭ			/0-Ò
	6⊕è CžÄ9⊕. 0			/0-Ò
	6⊕+^ /< /Ð) ;+Aä
;	+^ @ZV° ,÷(i) ;+Aä
	,O, -> B¹+^ 4~) ;+Aä
	-> B¹)A+e+^ Aš⊕=6¼G) ;+Aä
	.ž B¹<¹?µ) ;+Aä
	-> B¹)A,- 5 6⊕=6¼G) ;+Aä
;	DŸ•D ; 8X E) ;+Aä
	,÷2Ě+^ 5 D 0Á+e-Ö3ĭ) ;+Aä
A5>ä2ö,				

<Ö	óí@š 6 0' óí@š 9)C4' 0 .)M1, .œ	óí@š, .œ
;5 @ŠÖq			
	(; / . (D		- /0
	A5>ã(; (y ?!> Aú 63' (_<Aþ Í 0)÷2\$+y(<ÚB» 63' (_<Aþ Û	? 0Ü9È>ã0' @š (8É	- /0
	D D'BÍ)È6 0 :m(/ . ?@&	:m(Û TCE ?@& Û 7* (63' . &	- /0
	H E *Ô)÷?ÚEE + ^@Ž5àD7D/Á6,,; AñA -x+ ^@Z D È	9DF	- /0
	I D'BÍ)È:š 6 +e5àD7D/Á6,,; +e;5 @ŠÁ' / . ,æ+ ^) / ; ^	/ 1 3(- /0
	,3Á5 @Š7 IP S		- /0
	„3Á5 @Š7 P D[7 N\$	- /0
	„„3Á5 @Š7 8RF) ;+Aä
	J ,3Á. „3Á+e()ç,æ+ ^4~ ,GÉ5àD7D/Á6,,; Añ A -x+ ^4~D È	N\$	- /0
	K + ^@D/Á; ï 8 8É5àD7D/Á6,,; AñA -x+ ^@D È	N9	- /0
	M=f2è,á/Á+i0—É+R,3! ; È	,3) ;+Aä
	O.ž+ ^4~(D/Á=g0x+eE *Ô,O, D É9Èœ+ Aä È) ;+Aä
	R 1t? „, +e(D 9Èœ?ÉA	/ 1 3(- /0
	T + ^4~3Á?@Û1\4~8 5+0 D 4~ Í 0 ,_C€ ?±	1\4~ a	- /0
	D'BÍ)È<ÁJ +e?i>ÁÛ	0Ü9È>ã	- /0
	E "" DÑ D\$Á'	/È6»	- /0
	F „, 2û; ^4'	A „, 2û	- /0
	G "" DÑp,É	.m, +e	- /0
	L,O, -> B1+ ^4~ ,É9Èœ?ÉA È	A „, 2û) ;+Aä
	N , - 5 + ^4~6@=6¼G	\$	- /0
	P =r3ì8X E D ; É9ÈœAñ+eÑ È) ;+Aä
	Q CžÄ; Aä+e D\$É9ÈœD9A ; È) ;+Aä
	S "" DÑÖ6 É3H9ÈÛ4MtD"+n@ZG-TC0 ?-* *È C +j?)Á,) +i+i È	63' 4MtD" 71 >Ö-T	- /0
	U 1-AäAú ,3Á5 @Še(i 6¼' : 5) ;+Aä
	V >#), x>	‡ a ‡	- /0
	W,O, ,02È?Ù4~D * + ^@ZyD'?@ 63' =f) ;+Aä
	X =f) 63' =r3ì8X+e0;VA 9 AQA'D'BÍ)È.‡,) ;+Aä
	Y)14~ B(2ê@Be	P \$	- /0
	Z B¾•.ž+ ^@Z 72 9 <1?µ		- /0
	[,A0CE63' V+eDy,æ+ ^4~ „É9ÈœD'BÍ)È:š 6 È	D'BÍ)È> :š 6) ;+Aä
	(D AQ A8†6 8óA8 (' +eÍ) AQ(B>5>, / . 2è)Q ?+e+†9‡p D		- /0
	(D +e6@?µ;5 @Š		- /0
	* 4I Aä@ZÁC6,, @Z + ' 2í ,p,ÉD'BÍ)=f Í AÇ5 < Añ?@ ; +e(D 1Tª±(;5 @ŠJ Aä76A 3 1Ý; ;í +eÿ/É3•/ù)" VÍ 1tDäBªAäA		- /0

<Ö	oí @š 6 0' oí @š 9)C4` 0 .)M1, .œ	oí @š, .œ
	3 1ÿ, DE 0>=Š'0œÉ,Ý? 0ø+e9³0 / 4` E ,A> Í (U2è;ê D , *• D > Í * ,ñ+,,1•:ç> „ &í (i D9> J P Ê+e5ÿ/É)" VD		
	;5 @Š' í (< D AÇ >[2è0ÜD	;5 @Š' (< D 9 >[2è0Ü	- /0
	1t? „ Dð. +^8Y4Mt		- /0
	1t? „ DôÇ%0\$)è6¼MtD'Bí)È.‡, +eE ?,/. E *Ô1y6 +e+^3£D	E ?, P P ý E *Ô P P ý	- /0
	63' AÇ@ñt? „ Dôí 2èA5Aã>, C5>6™C)F=Xc)FE 0 +i?^+e,p,É1™±+^8Y4Mt D	5>, ?@t? „ Dô	- /0
	'• D'Bí)È=g0x+eA 9 "" DÑ63' í) 8ó,áD=f) .ž.) +e0'9@ 3A9• D		- /0
	63' +e1t? „ DôÉ5àD71, .ZAä -x;58 ÉAÇ >ã4q A 9 4Mt+)<ÆÚ K K , _,, 2ÛB<0ÿ. ;E9ì ;E* 1t? „ Dô÷2È+eA „ 2ÛB<0ÿ• (Ž K K 8E< +eA „ 2ÛB<0ÿ• D'Bí)È;Ö6 D @š .m, B»A 3 /R,) B• P P Í =`Añ>?.f BÔ, 8B +e6ÿÆp D	E ?, P P ý E *Ô P P ý	- /0
	"" DÑp; AÇ /0 D'Bí)È=g0x+eAñy "" DÑp; +e9^- // A 9 D		- /0
	5>, 1t? „ Dô		- /0
	5>, CB'4~) 0ÿ. 4Mt+e2è2à?µ;5 @Š		- /0
	,5 63' 1t? < ; Aä+e5>, í /Ú?É1™±7B1•/. 7Bê 5>, ;5 @Š K K *^- É,5AÛB 2YB-)¼4p5>>' 6x/0+e5>, É K K *^- É< Añ8E< 9 3 É	*-	- /0
	B 2YB-)¼4p5>>' 6x/0+e5>, 0 5>6™Í 5à*- AÇ<90ÇP * 9œTBº?P9ì í * ,è5>, +e1, .ZE D 5>, ?P* D) ;+Aä
	AÇ* Aä0; ++e5>; à8Q00 'Ä;7; 0'(Ž < ; +e7E 291™±*-;5 @Š	P P Ä 1P	- /0
	7B1•5>,) 6¼* Aä* 0 4GD5à*- 7Bê 5>, ; í A A' , +)<ÆD		- /0
	B»5 @Š)í D1í 5>, 7B1•+e4Mt) AÇê, í) 8ó) AÇñâ'Ž 63' 0-?Ù Aä+e< /Ö í D9È>, ,04r0 5>, =Xp+e)< C5>>' C+‡9‡0 5>, 0±=X< /Ö D		- /0
	D . oí)J=f2è. -") AÇ /Ö D		- /0
	4Mt=f) +)? +e1t? „ Dô+e2è2à?µ;5 @Š		- /0
)* Aä0; ++e5>; à+V0 'Ä;7; 0'(Ž .‡, +e7E291™ ?±;5 @Š	P P Ä 1P	- /0
	1t? „ Dô4Mt .‡, +eE ?,/. E *Ô1y6 0 +eÍ ; ?º0 ,A,j 1k/0=N+)<ÆE) 3Û+eA D7+)<ÆD	E ?, P P ý E *Ô P P ý	- /0
	+)<ÆF9ì 1t? „ Dô".‡, +eE , - 2A3ì í9Èœ5Üñ‡ , 2A3ì í BÓF9ì D"-¶/\$5 * 4ŽA „ D í) 8ó;(*‡Aú E 9ºA8 +d+)? ;è=r+e> D\$D 9œTAäŽ ? AÇTB D1‡, D +e9B;÷D ,_+e7E29 7B1•1•.m5>, D	P P Ä 1P	- /0

<Ö	Óí @Š 6 0' óí @Š 9)C4' 0 .)M1, .œ	Óí @Š, .œ
	1tDæ5à-Ú+]? ; 0'(Ž .‡, +e3Ž4GÍ 3Ž4G+> 1D; 0'3Ž4G AÇ? 0 Í; 0Å P IQÍ ,p? > +]? +eDB ,p? D	1	- /0
	Bx5 @Š)í D1í)F9ì 1t? ,, Dð1+e+)<AÇÜAñ2êA5 2V)M+eA', D		- /0
	1t? ,, DðMt .‡, +eE ?,/. E *Ô1y6 0 +e=N +]<AÉ ; ?¥0 1k/0 +]<AÐ1)* Aæ) 3Û+eA D7D	E ?, P P ý E *Ô P P ý	- /0
	AäŽ ? AÇTß D1‡, D +e9p;÷D ,_+e7E297B1• 1t? ,, Dð>, D9œT 7Bê 1t? ,, Dð>, Í 1tDæ+] <AÉ6½ = +^1t? ,, DðAÑ +e) ,÷ 1T±0Í)J D	P P Â 1 P	- /0
	+]<AÇ AÇñž,) +e< /Ö0 +]? (\ 8ñ,0 +e÷? D+)<AÉ :p) AÇñ• +e0 0Å9Ç-e@Z D		- /0
	Bx5 @Š)í D1í 1t? ,, Dð AÇê, Í A) 6'Añâ Ž 1t? ,, Dð-?Û Aä+e< /Ö Í D9E5>, ,04r0 5>, =X :p+e)< C5>>' C+‡‡0 5>, 0±=X< /Ö D		- /0
	1t? ,, DðMt(Ž <; 1,.Z+eAÓµ,A.j 1k/0 =N] <AÐB+)<AÇ9ì 1t? ,, DðNÍ 2ê,5+]<AÉe? ;à 1T± ;+R+eCœ D	E ?, P P ý E *Ô P P ý	- /0
	+]<AÇ9ì D"1t? ,, Dð+x) 0 -¶/\$ *' 1t? ,, DðŽA (€5 * Í) 8ó;(*‡AÉ 2ê6½ ? ;à;ê=r+e> D\$D		- /0
	AäŽ ? AÇTß D1‡, D +e9p;÷D ,_+e7E297B1• 1•.m5>, 0 5>6TMD	P P Â 1 P	- /0
	;5 @Š;Y/T Í AÇ?+]<AÉe? ;à *' 63' +e1t? ,, Dð D1+r* D		- /0
	>?5>, 1t? ,, Dð) ;+Aä
	1t? ,, DðMt .‡, +eE ?,/. E *Ô1y6 0 +e?£ +e+>AÉ ; ?¥0 1k/0 +]<AÐ1)* Aæ) 3Û+eA D7D• (Ž .‡, +e7E297B1•5>, É9ÉœAñ+eÑ É D) ;+Aä
	,55à-Ú+]? ; 0'(Ž <; +e3Ž4GD 0'3Ž4G AÇ? * 0 Í; 0Å P IQÍ ,p? > +]? +eDB ,p? D) ;+Aä
	Bx5 @Š)í D1í)F9ì 1t? ,, Dð1+e+]? AÇÜAñA', 0 9'// < /Ö+e0,,? D) ;+Aä
	2YB-Š*- 4Mt	@Š :p>?2YB-Š*- 4Mt) ;+Aä
	AäAÛ+F?ÿ+]? +e 63' +e1t? ,, Dð+e3Ž4G5 @Š) ;+Aä
	1t? ,, DðMt .‡, +eE ?,/. E *Ô1y6 0 +e?£ +e+>AÉ ; ?¥0 1k/0 +]<AÐ1)* Aæ) 3Û+eA D7D) ;+Aä
	'• (Ž .‡, +e7E297B1•5>, É9ÉœAñ+eÑ É D) ;+Aä
	4Mt/.)Q?+>AÉ *' Í 5à*- ; Aä?£+e+>AÉ) ;+Aä
	Bx5à* 1t? /T,5+]? ; 0'(Ž .‡, +e3Ž4GÍ; 0'3Ž 4G AÇ? 0 Í; 0Å P IQÍ ,p? > +]? +eDB ,p? D) ;+Aä
	Bx5 @Š)í D1í)F9ì 1t? ,, Dð1+e+]? AÇÜAñA', 0 9'// < /Ö+e0,,? D) ;+Aä
	AäAÛA?ÿ+^3£0 +^? +e 63' +e1t? ,, Dð+e3Ž4G5 @Š	@Š :p>?2YB-Š*- 4Mt) ;+Aä
	'• ,5Aä•0±1•,A?ÿ+^3£0 +^? +e 63' +e1t ? ,, Dð1T±3Ž4G5 @Š3Ž4GAÇ 0'B9Ç ,A?ÿ+^3£ 0 +^? :p,Y) ;(+F?ÿ? :p D) ;+Aä

<Ö	oí@š 6 0' oí@š 9)C4` 0 .)M1, .œ	oí@š, .œ
	'• (Ž .‡, +e7E297B1•5>, É9ÈœAñ+eÑ Ê D) ;+Aä
	'• >â6 +eL; 0š< 3Ž4GÛ)) [√ C ; D1Û) K K; 0'+e9QF 4GÛ 1 K K,A?ÿ+^3E+e?ÿ,^ Ü) [K K'• +FÛ+]<Æe1y6 E AäAÛA -Û?ÿ? :p+e 4GÉ0ÛŽ Ê D) ;+Aä
	Bx5 @š)í D1Í +^3E0 +^?) AŸÍ * 1t? ,, DôD) ;+Aä
	5>6™C)F=XC)FE	>?5>6™C)F=XC)FE D) ;+Aä
	=l.ž D . oí)J/. "" DÑ5 @š•oí@šE(- - /0A 9 D) ;+Aä
	0 ?-4Mt		- /0
	1t? ,, DôAÇm, B» 63' :p Í 0•; 0±1•5>, 0 < 1• 5>6™B1•0 7Bê; Í A) AÇ 8Eê, DAÇ AäE2@ 7Bê 0±1•5>, 0 < 1•5>6™D		- /0
)F=X.)FE AÇ /0. 0³(DŸeA 9 Í * % +e Añy <Ö ;+AäD)(8 >?)F=X)FE -ž 0B D) ;+Aä
	5>, CB'4~) 0B. 4Mt Û		- /0
	Ê>?5<(+^8Y+eÛ;(0 ?-+e4Mt Í AÇ1ñ;=Cž)A ; Aä)[: +e0 ?-AÇGD		- /0
	"" DÑ63' ; ; Aä+e5>,) AÇ(5>>' 8ñ? ; DôF5> , D	5ÛAñ AäDôF5>, D	- /0
	Ê+^8Y4Mt+e:0šAÇ +d1t*†@ZG ;(=l.ž 2YB-)%4pÉ* <Ÿ* C* 2 Bš™ 8E< 2@ñ? +R?µ6½+e)% 4pÉ*ÇE~Í * ,è Bx1';U) 0B D 2@ŸE .\ +e+P?µA5)AžYB-)4p9^// 2ê6½+e;6 < 0 9 - (..?^ D2.0™ * *É+e>, ?µ3•2Y5()4p+e;+Aä?µ D		- /0
	ÊB'4~) 0B. 4Mt 0BÍ 'Y 3%Aæ (D/Á+]<Æe) 0B É9ÈAñ+eÑ ÊAÇ* AäÛ K K=N K K/ =N' D":z> +e0 1' É3A0'.E4,,0B Ê Í 0 / =N' D":z> +e0 1' É8E< 4,,0B Ê K K6•; ?µ6½ +nAÛ=NÍ) 8ó2@ñ0 ;++e0 ?-?µ 6½+e8E< 1';U0 ;+R~)D+e1';U	/ç=N 4' D":z /0 1'	- /0
	4Mt=f) +]<Æe5>, 1t? ,, DôÛ		- /0
	Ê4Mt=f) +]<Æe1t? ,, DôAÇDD 8E4Mt+e+<ÆE Aä\$(D)÷(y ?)+e1t*†@ZGD		- /0
	C?šDÑšêA5()F9ì; 0 ;(5>É1t9ì; D		- /0
	BxB.8; +e; Aä<ÖB>ãÍ AÇ½P(, +y1t1•1t? ,, DôD		- /0
	Ê1t? ,, DôD'AäAÛ1•.m+]<Æe) 0B) AÇAæ .m, 8E< 9^// B<0BÍ 2 .} < 5è;(Aä•.m, 1t? ,, Dô E D 8EDË D		- /0
	Ê1t? ,, DôAÇ@ŸE .\ +e0 ?-8à,) DAäAÛ1•.m+] <Æe5>, /. 5>6™AÇ@ñLD' ,62 +e5>>' 0 1{2A. 0 ?-8à,) 2Z3Aç +e5>>' D 6,C %\$ / . 81 5>>' 2êAß¾ ; AäÍ AS < 5èBx5>2A. 0 ?-8à,) ,P6 B .LD'+e ,62 5>>' ; 0«p;(+i?' +eD	0 5> ,	- /0

<Ö	óí@š 6 0' óí@š 9)C4' 0 .)M1, .œ	óí@š, .œ
	Ê1t? ,, DâÇ%0§)ê; +d8E1•.m+]<Æ) 0 .ž.) < /Ö+]<ÆD	1•.m;) 0 .ž.) < /Ö+]<Æ	- /0
	Ê1t? ,, Dâ:e%0§AÇ 8E6'2ê2à+y² +]<Æ±1•B» 1';U(Ž6 D 0ÁD		- /0
	Ê1t? ,, Dâ:e%0§0) 27AÇ 8EB»7B1•1•.m5>, 0 5>6™; ?¥AÇ? / . 1k0+]? +e? ;à) 6'Á * 1t? ,, DôD(_A 9) ;+AäÚ1t? 8 ; 1t? ,, DôD		- /0
	Ê1t? ,, DâAÇf@šm, 0 , > Í +R1•.m5>, 0 5> 6™7B1•0 7Bê; Í 1t? ,, Dq AÇ' 63' +e.m, > D\$;ê=r D Cf?ŠA 9) ;(D 1t? ,, DâAÇE~-%0§A5D"(y ?)È D 8EDĚ 0 > A' Í+L;(,59'// A', (y ?)0'A5' ,÷+y >ÿD'A5ád D) - /0() ,÷A 9 D	1t? ,, Dq 0 =r5E 63'	- /0
	A - /0>ã4qA 9 Í; Aäý- /D/0>F0 ;XD 2.9°> E A5á D 1t? ,, Dqê, Ú K K5ý- /D/0>F0 ;XD B»CžÄ; Aä) BÄ= @ZG K KB»() ,÷.†, +eE) 3Ü+œÖß>ã1t? ,, DšD +^+e#ž) AÑ 5ý- /D/0>F0 ;XD +e? .œ) ;+Aä
	ÉAäÚMt(D/Á+)<Æe1t? ,, Dâ:e1•.m5>, 0 5> 6™AÇ@Æ .\ +e2ê2à?µA5á D AG-f+eê, D		- /0
	AäÚMt=f) +]<Æe>?5>>' 1t? ,, DôÚ	@š :p5ÜAñ>?5>>' 1t? ,, DôD) ;+Aä
	,, DâAÇ%0§)ê9Ě>ã1, .Z Ú K K5â+x+]<Æ +F,! +y1•.m D+R4Mt0 ,02Ě+]<Æ 6'¥M 0 C€÷(' +y4Mt0 ,02Ě K K6'2ê2à+y1•.mB«Í+eE *ÓD 0' A5>ã+e9'// ;^ 4' +e+]<Æ) ;+Aä
	Ê1t? ,, DâAÇ%0§)êB»8E1•.m+]<Æ) 0 ,5+]<Æ Bí)ê.ž.) +œ /Ö D) ;+Aä
	2YB-Š*- 4Mt=f) +]<ÆÚ) ;+Aä
	Ê2YB-Š*- 4MtAÇ@Æ2ê2à+e0 ?-4Mt D) ;+Aä
	Ê)[:> 1t*+@ZG-e5>,) AÇ»AÆ .m, 8E< 9'//) 0BÍ 0•; < 5è(Aä»•.m, 63' 0 C€ÿD 8EDĚ A) ?±D) ;+Aä
	Ê5>,) AÇ* AäÍ1';U0 9»AäÁ(...+e1';U D) ;+Aä
	6œ•; 1';U		- /0
	0±1•0BÍ * 4l 0±1•5>, C< 1•5>6™CD =g+†9†C+] ? / . 3Aç+e4,0BÍ AÇ»œœ•; 1';UD')ê Í 3HĚ=NC /ç=N+i+i É0Ü ,(& Ê D)* Aä' ? /ç=N%4pD')ê	- /0
	,áD 1t1t*†	.m, ;) A8*†0' +e 63') ;+Aä
	;5 @Š AäÆ *Ö)÷?ÚEE +^ @Z8F-ÄAÚ\4~Añ? D 0 D 4'+^@Z 9+eA8*†0' +e 63' D) ;+Aä
	63' AÇ%0§)ê• CžÄ; Aä<Öß" DÑT 8E'Ú+^) 0B ;() A8*†0' +eD• * % +e5 @Š,É1™±@Š D) ;+Aä
	63' AÇ%0§)ê• CžÄ; Aä" DÑ 1t? /T Í'Ú+^) 0B AÇ A8*†0' Í0•; '2) AäE2@è)Q?+e) 0BQ?-† A AÇ /0A 9 D) ;+Aä
	2YB-) 0B) ;+Aä

<Ö	óí@š 6 0' oí@š 9)C4` 0 .)M1, .œ	óí@š, .œ
	;58 '• CžÄ; Aä<Öß" DÑÍ 4Mt .‡, +eE ?, /. E *Ö1y6 0 +e+]<ÆT±5 @Š) ;+Aä
	((DÝ5D É• * % Ê,æB»5à-x2ê6½1t*†+^+e> D\$D) ;+Aä
	,5A0F9ì; 63' É) ; AäE2@.2ê-Ý/Ü ÉÍ +RF=X) ,÷+y)F9ì 0 9Ç)F9ì)FE ; Í;5D ,æB»5à-x2ê6½ 1t*†+^+e> D\$D) ;+Aä
	; AäA -x+^ @Z +nAû 9/.) -ÀAû 9+e+^8YD ; 8X3>ã; B Añy) 0ß1t*† D) ;+Aä
	1';U) 0ß) ;+Aä
	+R 63' '• CžÄ; Aä<Öß1t? / . "" DÑT Í A8†0' +e 1';U4,,0ßy?ì=l.ž A -x+nE 2Ú+e4Mt0ßB +y? 4MÍ * 4I AäAûm, 0 E / . -" 0)FE -" 'Æ) B *Ù+^) 0ß 2YB+e?, 5>, / . 3Áç 4,,0ßD) ;+Aä
	A!*" B»1t+y,, Dđ. 5à-xA8†0' +e1';U) 0ßD 0Á=l A5 (W0, -> B1+^4~0 \$Í4^C@Bp*ÔD É1\ 4~+^B+e2öB1+^@Z)Í .ž 9É D) ;+Aä
)C4` 1t+y,, Dđ. A8†0' +e1';U) 0ßD 0Á+e+^@ZVÍ) -Ú2>+^4~/ . +^ @ZV0\$< +^E D) ;+Aä
	+^E) AQÍ .ž) ;+Aä
	*p0 .G/%d.)14~;5 @Š	0ÜÖÈ>ã	- /0
	63' '• D'BÍ)É+e;Ö6 4Mt+^E *Ö)÷?ÜEE +^@Z 8x +e+^B•Í)C4` 63' ? /%+e;4B»G5+ - "" Í)C 4' 4~.ž 3(, Dê+e)14~ D DÄ Ú9ÈœD'BÍ)ÈB«Í 63' "" DÑr0'D7.D\$Í (;5 @Šç5 5aD7 7.D\$Í T±D DÄ ÚAçC4` C:Añ?D +^4~ D	8F 9DF ;4B»G5+Ú P 9\$ P \$ P \$ D'BÍ:m ?Üç	- /0
(YDÄÛ			

<Ö	óí@š 6 0' óí@š 9)C4` 0 .)M1, .œ	óí@š, .œ
;5 @ŠÖq			
	+^@D/Ä;ï 8 8S		- /0
	63' +e>yD'+^@Z Aqí .ž Ađ'bí)È.†, +e^@D /Ä;ï 8 D	8S N9	- /0
	,3Á. „3Á+e 63' '•)C;5 D		- /0
	,3Á. „3ÁÝ/ 2Ëy B:0ß+e 63' '•)C;5		- /0
	„3Á+e 63' '• 0)C;5 D	„3Á+e 63') ;+Aä
	A ,, 2û+e 63' AÇ =l+^;5 @Š		- /0
	„,, 2û+e 63' AÇ+l+^;5 @Š 8E+^B•+^@B» 8F ; +e(ç+^4~D":z \$D	A ,, 2û+e 63') ;+Aä
	,5 AŮ@ñt? ,, Dô+eA ,, 2û 63' í 1^T±5 @Š 5Ů Añ=f1t=r3ì8Xí B», Dâp)C4` >yD'+^@D,5 AŮ@ñ 4Mt+] ? +eA ,, 2û 63' í AÇ»8E=f1t+] ?)Ä,) > P P >â)C4` >yD'+^@D		- /0
	,5 AŮ_ ,, 2û+e 63' / 2@ñ> B'1t? ,, Dô÷2Ë+eA ,, 2û+e 63' í B» 63' +e> B' ,, 2û0 -> B'1t? ,, Dô)C4` >yD'+^@D) ;UAŮ-3Á?@e 63') ;+Aä
	>yD'+^@Z ? AÇ;e5 @Š-(1^T±5 @ŠeE -À+^@Z D D	4')CE -À+e>yD'+^@Z N9 0Ůž5 í -ž5	- /0
	Aä * 0 +^4~)C4`)1 @Z	0ŮË-ãŮ	- /0
	'• A5>ã D +^4~)C;5 Ů ,Q ,Q ,Q ,Q 9Èœ 63' 1-Ý/ +^@ZyD'B<0ßí1-B» ,Q1^T±(_;5 @Š	63' 1-Ý/ +^@ZyD'B<0ßí1-B» ,Q 1^T±(_;5 @Š ,Q N\$ +F> Ů N9	- /0
	,5 63' ; 0'A -xÇÖœµ. A -x-> 0œµ?ÖqD		- /0
	E /T 9Èœ P D[0 SHDN *ÔAŮ qí BÖD":z ,5 63' ; 0'A * P D[0 SHDN * 0 +^4~ í +^4~0œµ> 8Ñ6 ;5 @Š)1 @Zp*Ô+e0œµ D	,P D[N\$	- /0
	5à*- * 0 +e0ÄÖ; 0ÄAÇE A5 ;5 8 3Ä0•+Y02 ># ,) D		- /0
	5à*- * 0 AÇ"5 +^4~/ . +^@Z ?- =] D		- /0
	0)ê,æ+^4~B)1 @Zey >Ö ? =]		- /0
	2W >yD'+^@Ze)1 @Zê-ã4q+^4~,x> 6»? AÇ ? +eE -À+^@D 3•9~, Ů K K ,3ÁŮD +^ SHDN 0 qí 9, 1p*ÖD Ů K K „3ÁŮD +^ qD	„3ÁŮD +^ q	- /0
)C4`) 8Ñæ+^+^@Z	>?Ëy B<0ßB» 63' 6») ;+Aä
	; Aä * 0 +^@Z ,Ä: 8X2Ë5 ;E* +^@Z69 > N9D) ;+Aä
	,5 63' ; 0' *- * 0 í Cž> 0œµ-Ø *- D) ;+Aä
	5à*- * 0 +e0ÄÖ; 0ÄAÇE A5 ;5 8 3Ä0•+Y02 ># ,) D) ;+Aä

<Ö	óí@š 6 0' óí@š 9)C4' 0 .)M1, .œ	óí@š .œ
	9Èœ 0'+e *-* 0 D1+e9 A * 5ÜÄñ)M+^B») 8Ñæ+^ í AÇ ,Ä: 8X+e2Ë5 ;E* +^@Z% , > N9í D9• :p;W,5 @Š) ;+Aä
	Aä) 8X0"5 63' :p+e+^@Z) ;+Aä
)C+d+e>ÿD'+^@Z Cœ;5 @š ?Ó1+eE *Ô,æ+^+ @Z) ;+Aä
	Aä• /0))C4' >ÿD'+^@Z	„3Á+e 63') ;+Aä
	-• /0) AÇ 0'B»=I+^+e 63' :p í 8E+^B•+^@Z 8FD) ;+Aä
	1-AäAÛ\4~+^B•>Û-T+e 63' í B»Cž>ót^@Ze „ a „ ? > *‡; 0'Cž0Eµ* 0 íB» „ a „ ? > *‡; 0'-> 00Eµ* 0 D) ;+Aä
	AäAÜD 4~>Û-T+e 63' í; 0'Cž> 00Eµ+e* 0 D63' AÇ 0' 8F +eD 4~+^@Z) ;+Aä
	5à*- * 0 +e0ÄÖ; 0ÄAÇE A5 ;5 8 3Ä0•+VØ2 ># ,) D) ;+Aä
	:% , -• /0) ,Ä: 8X+e+^@Z ; ;E* +e2Ë5 +^@Z 8 _{RF} 8 _{RF} 8 _{RF} 8 _{RF}) ;+Aä
	5àD7 D ,5 63' ; 0' *-* 0 í Cž> 00Eµ-Ø *- D) ;+Aä
	Aä) 8X0"5 *' ,Ä: 8X4~9í 63' +e+^4~/ B» 63' ;E* „ 2Û+e+^@Z) ;+Aä
	>ÿD'+^@Z B»Cœ;5 @š ?Ó10"5 +eE *Ô- D +^ @Z) ;+Aä
(YDÄÛ			

<Ö	ÓÍ@Š 6 0' ÓÍ@Š 9)C4' 0 .)M1, .œ	ÓÍ@Š, .œ
;5 @ŠÖq			
	, E -> B';5 @Š		- /0
	9~, >yD'+^ @Z		- /0
	„3Á. „3Á+e 63' +e;5 @Š 1-B» q>ã1T± +e;5 @Š CŽC-> 0OµØA *- D	„3Á+e 63'	- /0
	„3Á. „3ÁÝ/ 2Ëy B'0B+e 63' +e;5 @Š '•)C4',æ+^@Z < AñC4'+e+^@Z D CŽC -> 0OµØ *- ?, Aû 8;D) 'Ý/ 2Ëy B'0B) ;+Aä
	„„3Á+e 63' +e;5 @Š '• 0 1-B» 8RF>ã1T± *- * 0 Í CŽC -> 0OµØ *- D	„3Á+e 63') ;+Aä
	B.†3Í.E8 +^B•<1?µ		- /0
	;58 4Mt+^ 8F+e.E8	9DF	- /0
	?Ü~?, Aû \$ +e 63' Û *' 63' +e1t? ,, Dō†)C4'+e.E8 +^@Z D +e>ã1V) 6)Í .ž 8F- D +e D		- /0
	?Ü~*ÓAû \$ +e 63' Û ;58 AQB .E8 +^@Z 8F+e+^5 4Mt Í ;5 @Š5 +e B.8; ,- 5 +^4^-AQ-i AÜ'BÍ)È• (Ž .†, +eO, ,0 2ËyÜ~D ,0 \$Í ,_C, 1p*ÖD D ,5Aû1-4MtB>D? /. (D/Á1t+yOÁ+e 63' í B.8; ,- 5 +^4^-D":z > \$D) ;+Aä
	„3Á. „3Á+eB.†3Í;5 @Š		- /0
	; 0' *- CŽOµ+e* 0 +^4' í, ÷)ê E í 5à E *- * 0 D5à*- * 0 AQB +^B•8 5+=M D*' „ 1h2Ë í =M 1hAQ5 „ a „ +e0ÁÖDQ-B>0' D 4^*- * 0 D 0Á+e0ÁÖ; 0Á> Va Ví 4^E D 0Á +e0ÁÖ; 0Á> P IQa P IQD K K +R 63' • „3Á5 @Š Í; 0'+e* 0 +^4^-D +i Aû SHDN 0 qÍ ,_C, 1p*ÖD D K K +R 63' • „3Á5 @Š Í; 0'+e* 0 +^4^-D +i Aû qD	=M 1h Û " " " " " " " " " " " " " " " " q N\$	- /0
	5à*- * 0 AQ'5 +^4^-) ?- í+^4^-) ?-) AÇã; ;58 AřD *Š0 :b 5H+e0, ? D		- /0
	„„3Á+eB.†3Í;5 @Š	„3Á+e 63') ;+Aä
) * Aä +e.E8 +^B•+^ @Z ()ç,æ+^+^4^-Aä 8RF D <ÇÚD ; 0' *- CŽOµ+e* 0 +^4' í, ÷)ê E í 5àE *- * 0 í +^@Z D +iAû 8RF í 5à*- * 0 AQB ;5AQ) +e- D; 2Ë í) /. .E8 +^@Z =MOµ D 4^*- * 0 D 0Á+e0ÁÖ; 0Á> Va Ví 4^E D 0Á +e0ÁÖ; 0Á> P IQa P IQD) ;+Aä
	5à*- * 0 AQ'5 +^4^-) ?- í+^4^-) ?-) AÇã; ;58 AřD *Š0 :b 5H+e0, ? D) ;+Aä
	„3Á. „3Á+e, E -> B';5 @Š	„3Á+e 63'	- /0
	63'; 0'+^@Z8FÍ +^B•+e()ç+^4^-9¾`D":z > \$D	9DF	- /0

<Ö	óí@š 6 0' óí@š 9)C4` 0 .)M1, .œ	óí@š, .œ									
	> D 6 9Ⓞ), í 5à*- * 0 /T.E8 +^@ZD)÷ P IQÚ Bx 0' 8F+^@zeE /T P IQÍ 9Èœ+^4~ ,F+eE ?µ÷4' - D 0 .G/%>), +y1V+ní BŎ°> 63' ;(9Ⓞ >), +eD	;58 *D+^9Ⓞ),	- /0									
	'• >ã4q;B; B»? AQAûE8 +^@zeCž D ; í ; 0' CZ 0œµ+e* 0 +^4~ í 5à-x- D * 0 A *- Ú SHDN É0 P DÍ È SHDN É0 P DÍ È SHDN É0 P DÍ È SHDN É0 P DÍ È SHDN É0 P DÍ È	„3Á P DÍ N\$ 1Tŕ±)C;5 0Úž 5	- /0									
	5à*- * 0 /T3ÁŎ•D"/Ø2 >#)		- /0									
	„3Á E -> B';5 @Š	„3Á+e 63') ;+Aä									
	63' ; 0' +^@Z8FÍ +^B+e()ç+^4~9%4` D":z > \$ D) ;+Aä									
	> D 6 9Ⓞ), í 5à*- * 0 /T.E8 +^@ZD)÷ P IQÚ Bx 0' 8F+^@zeE /T P IQÍ 9Èœ+^4~ ,F+eE ?µ÷4' - D 0 .G/%>), +y1V+ní BŎ°> 63' ;(9Ⓞ >), +eD) ;+Aä									
	Aä• /0) ,Ä: 8X1Tŕ±, E -> B';5 @Š,Ä: 8X2È5 +^ @Zœ D 9È>ã í 5à-x- D 1Tŕ±A CžA -> +e* 0 Ú 8 _{RF} 8 _{RF} 8 _{RF} 8 _{RF} 8 _{RF}) ;+Aä									
	5à*- * 0 /T3ÁŎ•D"/Ø2 >#)) ;+Aä									
	/0-Ö(DÝ	? 0ÜÈ>ã	- /0									
	5à*- * 0 /T, 6½D+^9Ⓞ),	5à*- * 0 /T, 6½D+^9Ⓞ),	- /0									
	9~// ?Ü~, 6½D>É	?Ü~, 6½D>É	- /0									
	+^@Z +^4~) ?~]=]0' 6)CÓ)J;58 AÇÜÄŕŎ *Š0 :b5H+œ÷?	;58 AÇÜÄŕŎ *Š0 :b5H+œ÷?	- /0									
	Bx5 @š)í D1) AÇÄ: 0 ?-< /Ö	;5 @š)í D'5ÜÄŕŎÄ: 0 ?-< /Ö	- /0									
	Aä()ç+^4~6¼4D":z > \$+eC+^@Z 8F+e+^B• .J+^ í,5 63' AÇ°; 0' A *- ,Q 8RF+e* 0 í B» * 0 /T í (D)÷ 8F P IQD 63' AÇD+^9Ⓞ), D	6½D+^9Ⓞ),	- /0									
	A +J*D+^9Ⓞ), í 1Tŕ±>ã4q)C;5 Ú K K)C4` 4~.ž;58 +e+^4~ í 8EE ?µ÷4' ÉBxCžó) +e D *±)C4` È) AÇÍ .ž P \$ 0 K K*ŕ0 .G/%Bx0') AÇÍ .ž)C4` D +e BxCfCœ;5 @š ?ÓTA50';58 3ÁŎ+^1t1•/Ø2 ># ,) A5T í AÇ9• :5 @š ?ÖÈ ; < 1Tŕ±+e)C4` >yD' +^@Z @š		- /0									
	,3Á. „3Á+e 63' +e;5 @š 1-B» ,Q>ã1Tŕ± +e;5 @š CžC-> 0œµ+eA *- D	+F> Ú N9 <table border="1" data-bbox="938 1951 1331 2065"> <tr><td></td><td></td><td></td></tr> <tr><td></td><td></td><td></td></tr> <tr><td></td><td></td><td></td></tr> </table>										- /0

<Ö	Óí @Š 6 0' Óí @Š 9)C4` 0 .)M1, .œ	Óí @Š, .œ
	„,3Á+e 63' +e;5 @Š '• 0 1-B» 8RF>ã1T± * * 0 Í CžC -> 00µ-Ø * D	„,3Á+e 63') ;+ Aä
	;5 @ŠŇ. ;5 @Š <)C4` +e+ @D ?, AŰ +i AŰ 8 ₃	8 ₃ N9	- /0
	63' =r3ì 8X+e6@=, E -> B';5 @Š		- /0
	;5 @Š Í D' BÍ)È.‡, +e=r3ì 8X) AÇ E Ü;5 @Š Í =r3ì 8X AÇ‡B>CžÄ.EE DĚ• D	=r3ì 8X5ÜAñ E	- /0
(YDĚŰ			

<Ö	Óí @Š 6 0' Óí @Š 9)C4` 0 .)M1, .œ	Óí @Š, .œ
;5 @ŠŇq			
	,A0E63' +eDý,æ+^4~;5 @Š) ;+ Aä
	;5 @Š: 8X+eA „, 4MtD",A0E63' +e 3(0 3(1 „, DôDBEB +e5à-x,, Dô-l.ž A -x*• 4K+e+.2@+eE 2Ú ÉAêA -x P +e+^E /. A -x ++e+^±E)è Ê4MtD",Ä: 8X+e4Ž=fA „, D 9Èœ[E (Ž 2ZC+^Aà+^4~+eT)ÓÍ 2ê; Aäl p?, +eE 2ÚD) ;+ Aä
	,A0E63' AÇ* AäD' BÍ)È:š 6 +eDý,æ+^4~ ,7RWD0 1T±A * ;5 @Š) ;+ Aä
	/0-Ô7q' (< DÝ) ;+ Aä
	1L;5 8 '• 5àD76,,; 4MtD" 8FÍ ;5 @Š.@XZ":z AÇ 2@ñ P \$ +e- 5 +^4~6¼GD)C4` 4~.ž;5 8 +e+^4~ Í 8EE ?µ,÷4` B>Cž-ó) - D *‡)C4`) AÇÍ .ž P \$ D 0 *p0 .G/%B>X') AÇÍ .ž)C4` D +e D) ;+ Aä
	,3Á. „,3Á+e 63' +e;5 @Š 1-B» ,Q>ã1T± +e;5 @Š CžC-> 00µ-ØA * D) ;+ Aä
	,3Á. „,3ÁY/ 2Ëy B<0ß+e 63' +e;5 @Š '•)C4` ,æ+^@Ž < AñC4` +e+@Z D CžC -> 00µ-Ø * ? , AŰ 8 ₃ D) ;+ Aä
	;5 @ŠŇ. ;5 @Š <)C4` +e+ @D ?, AŰ +i AŰ 8 ₃) ;+ Aä
	-%D[+^5 Í 9ÈĚ•D ; 8XÍ AÇ‡B>CžÄ.EE DĚ• D) ;+ Aä
	6)C0Í)J;5 8) AÇ >:9-// < /Ö+e0,,? D) ;+ Aä
(YDĚŰ			

<Ö	óí @š 6 0' óí @š 9)C4' 0 .)M1, .œ	óí @š, .œ
;5 @ŠÖq			
	63' +e9@), ;5 @Š		- /0
	6@Q5 @Š		- /0
	63' B\Ø2 >#) > ‡ a .+e0'9@ D(D)÷ K	‡ Í K	- /0
	63' +e6») =r3ì 8X) AÇ E	63' +e6») =r3ì 8X5ÜAñ E D	- /0
	9@), ;5 @Š		- /0
	1-Ý/ + ^ @ZËy ?@B<0B+e 63') 1T±(_;5 @Š) ;+Aä
	9-// B + ^ @ZËD' B<0B* 4K4Mt+e+ ^ @ZËy B<0B AÇ) * AäA -Ú=N, - 5 Í=N +eD 2 AÇ 8EB»5 @Š) 9%Ð D) ;+Aä
	2@ñ) =M+e,è ? ?µB<0B) 4K4Mt+e 63' í (y ?ì,5 63' +e5à-x+^4~5 2 1T±;5 @Š ;5 @Š)Q2Ë ,02Ë 8EB +e+^4~5 2 D 9Ëœ? =M@ / .) / ; ^ +eB<0B) 4K4Mt Í < 5èAÇ > A -x+^4~5 2 1T±;5 @Š) ;+Aä
	DË5ÜAñ2Ëy B<0B 8E< B<0B* 4K+e 63' +e;5 @Š)í ?Ó		- /0
	;58 4Mt+^+^B+^ @Z .\ -À; 63' Añ+^4~4~.ž +e .E8 +^B< D5 @Š P \$+eAñ?^D 2Ë í9ËœA2D í 8Q +,,2è* P \$(..Ð+^? AÇÜB<0B *Ô.G%+e+^ 4~ D		- /0
	;5 @Š^4~A5 P \$0 >è8Ñ+~1(+e;5 @Š^4~ +e) - É4^C@, 1p^ÔD ÉBx0' P \$ P \$ P \$ P \$ P \$ P \$ P \$ P \$ P \$)÷ ?Ú+e, 0Ä P IQ P IQ P IQ P IQ P IQ P IQ P IQ P IQ P IQ 0Üž 5	- /0
	5àA) (D)÷ +^*Ð+^9@ /CD@• É0• P IQ6»>#) (..Ð?, Aú .É		- /0
	4MÛÁÇ 63' E 9@,,+eŽ6 >#) É1-,5 A8†0' +e 63' É/. 4~.ž 63' +e+^4~ D		- /0
	9Ëœœ Añ+e,è ? ?µB<0B,0 2ËÍ BQ5 @Š@ D,5 @Š @Z AÇBx0' í A5) 6 9-// =r3ì 8Xk CpD		- /0
	9Ëœœ 63' ,, D0Ä+e+ ^ @ZT#^+nAú 8Fí BQDD +~1{ +^4~ í + ^ @Z/ù 8F) (D)÷ P IQD) ?ÉA B01TM ?±4MÛ+e+^4~0ÁÇ D +^B<AÇ@ñ- 5 +^4~6¼GíB»9-// =r3ì 8X E 8Ñ<) 0 >yD'+^4~ Æ *Ôè*Ð+^+e+^4~ D) AÇí .ž D'Bí :š 6 +e- 5 6@=6¼GD	____ 9 ____ N\$ FRV Ä) ;+Aä
	EÉAñ2Ëy B<0B 8E< B<0B* 4K+e 63' +e;5 @Š ?Ó	5ÜAñ2Ëy B<0B D) ;+Aä

<Ö	oí @š 6 0' oí @š 9)C4` 0 .)M1, .œ	oí @š, .œ
	63') * Aä^ @ž 8F+e.E8 +^B•J+^ Í+^B•AÇ@ñ ,- 5 +^4~6¼GÍB»Ø// =r3ì8X E 8Ñk) 0 >ÿD'+^ 4~ D E *Ö2ê*D+^+e^4~D) AÇÍ .ž D'BÍ)È:š 6 +e,- 5 6@=6¼GD) ;+Aä
	9Èœ5ÜAř6 >ô+e^4~4~.ž Í AÇtDæT?± D;5 @š ?ÓD) ;+Aä
	/0-Ò7α' ((DÝ		- /0
	/È6»?@ 63' Û (Ž6 >#ž AÇ, Aû .DB»r3ì8X E P LQT Í (Ž6 >#ž) AÇÍ .ž D=> /Ø2 >#) . D B»5 @š)í D1Í 5ÜAñm<P/4p7^	/Ø2 >#) > ‡ E -À>#ž Û ‡ ‡ . . . P LQT>#ž Û ‡ ‡ . . . 5ÜAñm<P/4p7^ 1G	- /0
	/È=f?@ 63' Û 5ÜAñm<P/4p7^) ;+Aä
	A8†0' +e 63' Û ;5/T Í ,5,á /Á+i0-^ÔAÛ +iAû ,3 +e 63' Í ; Aä ((DÝ5D ; 0' 1+e4GÉ0Û * % È) AÇ†0' *Û+^) 0RÍ * 4l 63' ' CžÄ; Aä" DÑTB»5 @šÑ A22ê†0' +e*Û+^) ,÷=f D) A8†0' +e 63' D) ;+Aä
	9Èœ=r3ì8X E Í 63' AÇAř6 >ô+eCAñ?^/. Aä\$,0 2È+e0,,? D> 4l @š -A 9 Í AÇ* Aä+iAû 8F+e.E 8 +^ @Z 0' P LQÍ 4~.ž+e^4~) AÇÍ .ž P \$ ÉAñ^D È D	9DF P \$	- /0
(YDÄÛ			

<Ö	óí @š 6 0' óí @š 9)C4` 0 .)M1, .œ	óí @š, .œ
;5 @ŠÖq			
	,- 5 6@=6¼4G		- /0
	(_;5 @š ;+AäAÛ>ä4q 63' Û ÷3Á> /É=f; Aäí) 80" DÑB»• (2A3ì A5=f+e 63' D B» 71 >Ö-T /. 0 77>Ö-TD11-AäAÛ4Mt 1 3(+e 63' D) ;+Aä
	;5 @š 8 AÇ D' BÍ)È* 'Ç+e;Ö6 ;J" DÑ) 8ó4Mt +eE *Ö1y6 0 +e+] ? Í B»16»+e+^3£(D4•+e E *Ö)Ä,) > 5à-Ú P D		- /0
	63' (_:Ž0' 8E=r3ì 8XAÇæB»A -xCžp? 6ÿ1 6»Í6ÿ /1)A6 3ì 63' =f(Ž6 a P P D		- /0
	/1+eA 6 É) ;(+x6 È(D)÷*Ö2ÈÍ A5,, 6½ D' BÍ)È +e;Ö6 4Mt+^B•+^3£ D		- /0
	;58 DÿY		- /0
	2@ñ) 4K4Mt+e,è ? ?µB<0ß) 'Ý/ A -x0 ,A-x /. < ;W+e,è ? ?µB<0ß+e 63' Í,55à-x+^4~5 2 AÇ >äW+e,p; ,÷(' DÿY9p>x A E +e;58 D B» /. D1< ;W+e+e+^@zÿD'B<0ß). +^@Zÿy B<0ßAÇ* Aä+R+e=Nß 6,,6Ä<ÇÛ>P3•*Û<ÇÍ A5 9~(D6») 4Mt Í 4Mt+e1y6 /. D=> +e)%4p 3F9ÉÍ ;XD A50' Ý DÑ) (...D		- /0
	;5 @š ?Ö		- /0
	(_;5 @šÇ5, _-x) =M+e;5 @š.D\$1T±5 @š,55à-x 7.D\$ D/. E)* AäA E +F,! DÿY+e;58		- /0
	DÉ:š 6 +e,- 5 6@=6¼4G5 @š) ;+Aä
	;58 4MtD"2@ñ /0:š 6 +e,- 5 6@=6¼4G+eB.8; ,- 5 +^4~0' - /0(Ž +e.G5+AS^ C+^@z 8FV+e .E8 +^B• D) ;+Aä
	B»^@Z 4,,/T+e ,, +^1h,) /. ,, +^1h,) *‡1t= ,- 5 1T±_* ;5 @šÖœ2è-Ý/Û+e0 2èD9£%_ +e 6») 0 =f) +e=r3ì 8X E Í5à* AÇÝ/Û0 D9£%_ ? AÇ=r3ì 8XD9Èœ=r3ì 8X) 6½Ý/Û0 D9£%_ Í BÇ5 @šDD D) ;+Aä
	EÈ+n,- 5 +^4~;5 @š		- /0
	1L;58 1t+^+^@z 8FV+eE8 +^B•:p Í +^B•+eB... 8;,- 5 +^4~AÇ) [8 +eE *Öž +^4~(D/Á,O, +^4~ D É9ÈœD' BÍ)È:š 6 È+e (WÍ 8EG5+AS^ ' (Ž .‡, Í = +^; 0Ä> Va VD 9ÈœD' BÍ)È5ÜAñA 9 Añ=f) +ež +^4~(D/Á Í)* Aä \$+eB.8;,- 5 +^4~ DB»^@Z 4,,/T+e ,, +^ 1h,) *‡1t= ,- 5 +^4~1T±_A * ;5 @š	+^B•B.8;,- 5 +^4~ Û \$Í .G5+ASù D	- /0
	/0-Ö7q' (< Dÿ		- /0
	B»,- 5 6@=6¼4G5 @š Í+^B•,- 5 +^4~AÇæD' BÍ)È < A 9 +eA -x=r3ì 8XÉ6») +e0 =f) +eÈ,02ÈD	6») =r3ì 8X E D	- /0

<Ö	Óí @Š 6 0' 0í @Š 9)C4` 0 .)M1, .œ	0í @Š, .œ
	<p>> 2 8E< +e> 0³(‹ DÝ@Š +e6») +e/. 0 DĚÄte=r 3ì8X?É1T±Û 9Ěœ=r3ì8X E ÍAÇr6 >õ+eCAñ?^ +e/. Aáz\$,02Ě +e0,,? Í > 4l @Š -x A 9 ÍAÇ* Aä+I Aû 8F+e.E8 +^@Z 0' P lQí4~.ž +e+^4~) AÇÍ .ž P \$ÉAñ ?^D Ê D</p>	<p>9 DF P \$</p>	<p>- /0</p>
	<p>;5 @Š; 0ÁÍ (BD 0 :U)) AÇ•:v D</p>	<p>(BD 5ÜÄr9•:v D</p>	<p>- /0</p>
	<p>A8†0' +e 63' Û ;5/T Í ,5,á/Ä+I 0-ÖÄÛ +I Aû ,3 +e 63' Í ; Aä (‹ DÝ5D ; 0'A -x 1+e4GÉ0Ü * % Ê) AÇ *†0' *Û+^) 0BÍ * 4l 63' '• CžÄ; Aä“ DŤTB»5 @ŠNAZē*†0' +e*Û+^) ,÷ =f D</p>	<p>) A8†0' +e 63' D</p>	<p>) ;+Aä</p>
	<p>„L+nAûš 6 +e,- 5 6@=6¼G+e 63' +e) * ;5 @Š</p>		<p>) ;+Aä</p>
	<p>D9• +e;5 @Š +L+^ @ZËy B(0B) ,- 5 D Aä -xCZ~ +e+^Aä+^4~É 0 8E< /0;+e) ?^ Ê BxCžì) +e+^@Z 4,,/T+e „ D" „ +^1h,) *†† ,Ä 63' 1t=l,- 5 D+^Aä+^4~AÇE .\ -ÄA5[:) ?Û+^ Í +L9~// 9 3 >žZ) AÇÍ .ž ,QD</p>		<p>) ;+Aä</p>
	<p>> 9^(DB*†,Ä+^Aä+^f) =r3ì8X) , E Í< Añ+e=f) =r3ì8XAÇÉ=] D< ; B .E8 +^B•• 4KæD\$D</p>		<p>) ;+Aä</p>
	<p>;5 @Š ?Ó</p>		<p>) ;+Aä</p>
	<p>(„;5 @ŠÇ5 „-x) =M+e;5 @Š.D\$1T±5 @Š,55à-x 7.D\$ D/. E)* Aä A E +F,! DÝY+e;5 8</p>		<p>) ;+Aä</p>
	<p>DĚ;58 4MtD"2@ñ /0:š 6 +e,- 5 6@=6¼G+eB.. 8;,- 5 +^4~0' - /0(Ž +e.G5+AS^ C+^@Z 8F +e.E8 +^B• D</p>		<p>) ;+Aä</p>
	<p>B*^@Z 4,,/T+e „ +^1h,) / „ +^1h,) *†1t=l ,- 5 1T±_ * ;5 @ŠĚœ2ē-Û+e0 2âD9£% +e 6») 0 =f) +e=r3ì8X E Í5ä+^ AÇÝ/Û0 D9£% ? AÇe=r3ì8XD9Ěœ=r3ì8X) 6½Ý/Û0 D9£% Í BÇ5 @ŠDD D</p>		<p>) ;+Aä</p>
	<p>EĚ1L;58 1t+^+^@Z 8FV+e.E8 +^B•:p Í +^B•+e B.8;,- 5 +^4~AÇ) [8 +eE *Öž+^4~(D/Ä,O, +^ 4~D É9ĚœD'BÍ)Ě:š 6 Ê+e (WÍ 8EG5+AS^ '• (Ž .†, Í =l+^; 0Ä> Vá VD 9ĚœD'BÍ)Ě5ÜÄrA 9 Añ=f) +e.ž+^4~(D/Ä Í)* Aä \$+eB.8;,- 5 +^4~ DB*^@Z 4,,/T+e „ +^ 1h,) *†1t=l,- 5 +^4~1T±A * ;5 @Š</p>		<p>) ;+Aä</p>
	<p>/0-Ö7q(‹ (‹ DÝ</p>		<p>) ;+Aä</p>
	<p>B»,- 5 6@=6¼G5 @Š Í+^B•,- 5 +^4~AÇÄD'BÍ)Ě < A 9 +eA -x=r3ì8XÉ6») +e0 =f) +eĚ,02ĚD</p>		<p>) ;+Aä</p>
	<p>> 2 8E< +e> 0³(‹ DÝ@Š +e6») +e/. 0 DĚÄte=r 3ì8X?É1T±Û 9Ěœ=r3ì8X E ÍAÇr6 >õ+eCAñ?^ +e/. Aáz\$,02Ě +e0,,? Í > 4l @Š -x A 9 ÍAÇ* Aä+I Aû 8F+e.E8 +^@Z 0' P lQí4~.ž +e+^4~) AÇÍ .ž P \$ÉAñ ?^D Ê D</p>		<p>) ;+Aä</p>
	<p>;5 @Š; 0ÁÍ (BD 0 :U)) AÇ•:v D</p>		<p>) ;+Aä</p>

<Ö	oí@š 6 0' oí@š 9)C4` 0 .)M1, .œ	oí@š, .œ
	A8†0' +e 63' Û ;5/T Í ,5,á/Á+i0-ÔAÛ +iAû ,3 +e 63' Í ; Aä (‹ DÝ5D ; 0´A -x 1+e4GÉ0Ü * % Ê) AÇ *†0' *Û+^) 0BÍ * 4l 63' '• CžÄ; Aä“ DÑTB»5 @šNA22ê*†0' +e*Û+^) ,÷=f D) ;+Aä
(YDÄÛ			



<Ö	0í @š 6 0' 0í @š 9)C4' 0 .)M1, .œ	0í @š, .œ
;5 @ŠÖq			
	B»+n@ZĜ-T.k CpA^8Q+e 72 9 >ã;5 @Š		- /0
	9Ěœ 8F-ÅAŰ +i Aû 8,Í >??ÉÍ™±(_;5 @Š	8F 9 ! 8, 9 >??ÉÍC;5 D	- /0
	;5 @š ?Ó) ;+Aä
	AQ* Aã£+e;5 8) • D' Bí)Ě;Ö6 +eCžÄ; Aä<ŰB " DŇD) ;+Aä
	63' (_:Ž0' 8E=r3ì 8XAÇæB»A -xCžp?~ 6Ÿ1 6»Í6Ÿ /1)A6 3ì 63' =f(Ž6 a P P D1 +e6»Ž6 -" -" (BD 0 :U) D1 +eA 6 É) ;(+x6 Ě(D)÷*ÖĚÍ A5,, 6½ D' Bí)Ě+e;Ö6 4Mt+^B+^3£ D) ;+Aä
	;58 AQMt+^ 8, +eE8 +^@Ž)÷?Ù 0Ä W V Í+^@ZBŉĚŽ % < ; í 0 D' Bí)Ě• +e? Z :š 6 +etp-Ä+e 72 9+^@Z -+^@B•AQ½E* A -xE .\ -Ä+et^4~ ÍA5~(DB»5 @š)í D1 63' ,, Dâp+et^@Z 0 +^E+^ 8,+e A5-ãí 0 6½E* :š 6 +e 63' +e- 5 6@=6¼GÍ 4^ C@, 1p?, D D) ;+Aä
	1•1tDæ», 0' 8,T ÍAÇ»58 :p; 0'+iAû 8FV) 2@ñ=M@š^4~6¼G+et^@Z P IQD;5 @š-8; D 0Ä+e; 0Ä0ÄÖAÇ 2ê6½Í) 86B»ŉ// 9 3 >ã) AÇ)Í.ž P VD) ;+Aä
	/0-Ò7q' (< DÝ) ;+Aä
	B»5 @š)í D1Í (BD 0 :U)) AQæ D) ;+Aä
	,5,á/Ä+i0-ÖAŰ +iAû ,3 +e 63' Í ; Aä< DÝ5 D; 0' 1+eAGÉ0Ü * % Ě) AÇ†0' *Ù+^) 0BÍ * 4l 63' • CžÄ; Aä" DŇTB»5 @šNA22e*† 0'+e*Ù+^), ÷=f D) ;+Aä
	72 9 .kCp,,; 9Ěœ=r3ì 8X E Í 63' :pAQr6 >ô+eCAŇ?/. Aã\$,02Ě+e0,,? D > 4l0í)JCfA A 9 Í ; 0'+iAû 8F+eE8 +^@Z P IQÍ 4~.ž+et^4~) AQÍ.ž P \$AŇ^D D) ;+Aä
	72 9 6@=6,,; K KB», 0' 8FV8;0ÁÉB», 0' 8,T Ě Í 63' AÇ (D)÷9@), D9ĚœB», 0'+^@ZBFV+e9Ç; 0Á6» 4~.ž 63' +et^4~0 8EG/% B»B»0' Í B@°> 63' ;(9@), DĚ• D K K9œŇ'2 ;58 4MtD" 8FÍ;5 @š.@šD":z AÇ@ Añ P \$ +e- 5 +^4~6¼GD)C4' 4~.ž;58 +et^4~ Í 8EE ?µ,÷4' ÉB»Cžó) +e D †)C4' Ě) AQÍ.ž P \$ D 0 *p0 .G/%B»0') AQÍ.ž)C4' D +e D) ;+Aä
	,3Á. „3Á+e 63' +e;5 @š 1-B» ,Q-ã1™± +e;5 @š CžC-> 00µ-ØA *~ D) ;+Aä

<Ö	Óí @š 6 0' óí @š 9)C4` 0 .)M1, .œ	óí @š .œ
	,3Á. „3ÁÝ/ 2Ëy B<0ß+e 63' +e;5 @Š '•)C4` ,æ+^ @Ž < AñC4` +e+^ @Z D CzC -> 00EµØ *~ ?, Aû 8SD) ;+Aä
	„,3Á+e 63' +e;5 @Š '• 0 1-B» 8RF>ã1T± *~ * 0 Í CzC -> 00EµØ *~ D) ;+Aä
	-%D[+^5 Í 9ÈDÖ•D ; 8XÍ AÇ†B»CžÄ.EE DÖ• D) ;+Aä
	6)C0Í)J;58) AÇ >:9-// < /Ö+e0,,? D) ;+Aä
	B»ÀÉD1Ê@ZÖ-T+ek CpA^8Q+eB¾ .ž +^ @É 72 9Ê >ã5 @Š	*-)[8 1-4MtD" 71>Ö-T) ;+Aä
	4MtD" 3(,,) AäAŮ.†^>Ö-T+e 63' AÇ (Ž % B» 8>ã1T±;5 @Š) ;+Aä
	AÇ* Aä?E+e;58) '• D' Bí)È;Ö6 +eCžÄ; Aä<Öß " DŇí+F? 0 ,A? ;58 4MtD"=] +e;5 @Š 5 0 +i ?^+e+^5 D+i ?^+^5 =]0Ûž5) ;+Aä
	63' (_:Ž0' 8E=r3ì 8XAÇæB»A -xCžP? 6ÿ1 6»Í6ÿ /1)A6 3ì 63' =f(Ž6 a P P D1+e6»(Ž6 -“ -" (BD 0 :U) D1+eA 6 É) ;(+x6 È(D)÷*ÖÈÍ A5,, 6½ D' Bí)È+e;Ö6 4Mt+^B+^3£D) ;+Aä
	B» 0' 8FV /T Í =.ž (v/0 6 B» / ? +e „ +^1h,) *†,5;5 @Š ; 0' 8, DB» P V /T Í 6 Dq̄ (v/0 D +^B• 8FV+eB.8;,- 5 +^4~ AÇi AŮ' Bí)È:š 6 +eE *Ö.ž +^4~ (D/Á+e,O, +^4~+e>F(WÍ9Èæ5ŮAñš 6 E *Ö.ž +^4~ (D/Á ÍBÓ \$ D~4~B«Í>T)O> D 72 9(..@ZXE* +eB.8;,- 5 +^4~ AÇi.ž 5 +^1{D" \$ D D1µ? 1t+y+e 63' 3E=fÍ 8FV, 0'+^;58 :p(D)÷ P Q) ,02ÈÍ D D"2Ëy 6 D9£,02ÈD) ;+Aä
	/0-Ò7q((DÝ) ;+Aä
	B»5 @Š)í D1Í (BD 0 :U)) AÇæ D) ;+Aä
	,5,á/Á+i0-*ÖAŮ +iAû ,3 +e 63' Í ; Aä< DÝ5 D ; 0' 1+e4GÉ0Û * % È) AÇ†0' *Û+^) 0ßÍ * 4l 63' '• CžÄ; Aä" DŇTB»5 @ŠNA22ê† 0' +e*Û+^) ÷=f D) ;+Aä
	72 9 .k Cµ,,; 9Èæ=r3ì 8X E Í 63' :pAÇrß >ö+eCAñ?/. Aä\$,02È+e0,,? D > 4l0Í)JCfA A 9 Í ; 0'+iAû 8F+e.E8 +^@Z P QÍ 4~.ž +e+^4~) AÇÍ .ž P \$Añ?^D D) ;+Aä

<Ö	oí @š 6 0' oí @š 9)C4` 0 .)M1, .œ	oí @š .œ
	72 9 6@=6,,; K KB» 0' 8FV8;0ÁÉB» 0' 87/T Ê Í 63' AÇ (D)÷9@), D9ÈœB» 0'+^@Z8FV+e9Ç; 0Á6» 4~.ž 63' +e^4~0 8EG/% B°B»0' Í B@°> 63' ;(9@), D@• D K K9œT'2 ;58 4MtD" 8FÍ ;5 @š .@ZD":z AÇ@ Añ P \$ +e- 5 +^4~6¼GD)C4` 4~.ž ;58 +e^4~ Í 8EE ?µ,÷4' ÉB»Cžó) +e D *†)C4` Ê) AÇÍ .ž P \$ D 0 *p0 .G/%B»0') AÇÍ .ž)C4` D +e D) ;+Aä
	,3Á. „3Á+e 63' +e;5 @š 1-B» ,Q>ã1T± +e;5 @š CžC-> 0œµ-ØA *- D) ;+Aä
	,3Á. „3ÁY/ 2Ëy B<0ß+e 63' +e;5 @š '•)C4` ,æ+^+^ @ž < AñC4` +e^ @Z D CžC -> 0œµ-Ø *- ? , Aû 8SD) ;+Aä
	„,3Á+e 63' +e;5 @š '• 0 1-B» 8RF>ã1T± *- * 0 Í CžC -> 0œµ-Ø *- D) ;+Aä
	-%D[+^5 Í 9ÈD@•D ; 8XÍ AÇ†B»CžÄ.EE D@• D) ;+Aä
	6)C0Í)J;58) AÇ >:-9// < /Ö+e0,,? D) ;+Aä
(YDÄÛ			

<Ö	oí @š 6 0' oí @š 9)C4' 0 .)M1, .œ	oí @š, .œ
;5 @ŠÖq			
	*ÜAñŕĭ+^3ŕ. +^? +eA', ; 63' 0' 8E4Mt	.m, ; 63' í) *Ü+^B•9ĭ? D) ;+Aä
	A', ; +e 63' AÇ-ÂJ Añ+^? .m, DÑĐ\$Í A5,,; 4M 1tD"1t? ,, Dđ ,, =X†+e+]? 6 ;=AÇĜÉ'Y3%ŔE 1k Ê í) ; +]? 2YB-)D6 ;=6†< D +]? /Ă<, É9ÉAñ+eÑ ÉAÇ±1•B»^? .m, DÑĐ\$ŕ D =I.ž D . oí)J 3•oí @ŠE(- - /0 A 9 D) ;+Aä
	+]? , > +eAñ?^?µ2ê)* Aä=] < ; +e:%ŔY1Tŕ±>ã 4q;5 @Š•oí @Š) ;+Aä
) 2ê)Q? +e 63' '• .J 0 DĜ•1Tŕ±5 @Š5 @Š•?ŕ+e ;58 :p 1Tŕ±D) ;+Aä
	2ê)Q? +e 63' Ađ' BÍ)Ē.†, +e()ç 1y6 +e+^3ŕ1™ ?±5 @Š) ;+Aä
	2ê)Q? +e 63' +eĭ+^3ŕ+]<AĖ +^? +e+<Aŕ9ĭ1t ? ,, Dđ 5>, 7B1•D"-ŕ/\$; +]<Aŕ A8A' > > D D) ;+Aä
	+^? .m, DÑĐ\$• CžÄ,ŕ,É; Aäí 0±1•5>, É9ÉAñ+e /Ñ ÉAžŽ .†, +eŕŕ;÷ D ,_ +e7E297B1• D) ;+Aä
	;58 DŕŕE DÑT í -ŔE)ê) ,÷ 2ZAÇ ./0 +d8A+ŕ/\$ *† í 8ó) 2ê6½? +^3ŕ0 +^? B% >ô+y=çĭ;58 D) ;+Aä
	;58 ,æDŠ»5 @ŠÑĐ\$ŕ í; 1Tŕĭ;58 *†+e+^3ŕ0 +^ ? +eDŠ *†AŕšD > D\$D) ;+Aä
	9œŦ AäA5>ã+e3Ž4G5 +^3ŕ0 +^? 3Ž *~ Ū K K 1 í 9ÉœO, +^4~) *ŌAû \$ / ., O, +^@Z ? , Aû+i Aû 9Ū K K 1 í 9ÉœO, +^4~) *ŌAû \$ / ., O, +^@Z *ŌAû 9Ū K K 1 í 9ÉœO, +^4~*ŌAû \$ D ; 0'3Ž4G AÇ (:p>?* 0 í 5à~; 0A> VD AÇŦACŪ=M ,5 9ĭ+^3ŕ+e< Añ) ,÷ É?Ŕ? C2YB-/ . /Ă<, É; 0'? =Me3Ž4GD) ;+Aä
	> 4l)C4' Dŕ > A' í B»5 @ŠĒ 8Ñí +R+^3ŕ0 +^?)ñ;=3Ž4G B»8Eĭ;58 0 +^3ŕ/Ă<, ,,) *ŌB• P P *†E A (0" D,5 AŪ) 2ê)Q? 63' í 9Éœ;58 0 +^3ŕ/Ă<, 5ÜAŕ6 9~+e,) í BŌ»58 (<Aŕ E A -ž 0'(0" D) ;+Aä
	;5 @Š' í B»^3ŕ0 +^?)ñ;=3Ž4G í)C4' +^3ŕ0 +^ ? :p (0"? ,5 AŪ5 8 0 +^3ŕ/Ă<, +e> A' D) ;+Aä
	+^3ŕ0 +^?) AÇ', P P A5p D ,5 AŪ2ê)Q? 63' í B»1t? ,, Dđ 1+]? ,,)) AÇŕ6 >ôA' > Ū,5 AŪ) 2ê)Q? 63' í +^8Y4Mt) AÇ 0 2ĒD) ;+Aä
) 2ê)Q? +e 63' AÇ-ÂJ - /0 * %7 / . * %7 +eĭ+^3ŕ0 +^? í 8E+<Aŕy6 0 AÇ+/0 AŪ 63' 0' Añy 8X0ŕ+eE *Ō, O, D D =I.ž D . oí)J C)C4' / . oí)J 9ĭ+^3ŕ0 +^? - /0 * %7 / . * %7 É;+Aä É3•oí @Š - - /0 A 9 D) ;+Aä
) 2ê)Q? 63' +e:%ŔSAÇ½á D 9ĭ+^3ŕ0 +^? B»1™ 9ĭ 63' ; ;=+^ž.) =.9) ;+Aä

<Ö	0í @š 6 0' 0í @š 9)C4' 0 .)M1, .œ	0í @š, .œ
	,á D .ž,) =.9 +e/Á<,AQ* Aä2YB-)%(pD')ê í) * Aä 2ê2à+e.m, ,p,É Ü5>?FDÖel';U+Pê í >?5<(5D1' ;U/Ú;(- " Ař2YB-)%(pí 2Z) AÇæ +^? /Á<, D) ;+Aä
	=I.ž D . 0í)J/. Aä-] +e;5 @ŠND\$1T±=.9 ;5 @Š 3•0í)J8E(- - /0 A 9 D ;5 @Š»?£+e;5 8 :p 1T±D) ;+Aä
	;5 8 .m, B»5 @ŠND\$e», 0 .Z:p D+R< B»D10Á> D\$ í 1T9í;5 8 *†+e9Í+^3£0 +^? +eDB *†AŮšD > D\$í) =I.ž'», DBD 63' AÇf@š > Í=I.ž+~1{'», 0 .Z+em,) 0RB '», DBD 0Á+e2A3í í ; ;5 @ŠND\$e», 0 .ZB»Cœx '», .ž)í D1+^? < E +e/B? A', E ?, D > 4I=I.ž; @Š8AÛs B»5 @Š +^? /B? A', E ?, +e" DŇ D\$í =.9 DŇD\$e.ZBÍAG½ "" DŇB»», 0 .Z:p 63' +eØD7) =MD 0'A8AŮ+~1{ D) ;+Aä
	+^3£0 +^? 0'D9FE -> B' í < 0'+e4G Ů K K 1 í AäAŮ+^3£0 +^? +e()ç 1y6 0)í .ž P P +e 63' K K 1 í AäAŮE< 63') ;+Aä
	+> <AEI A5 63' ,O, +^4~0 >ã4qt^4~ í4^CØ9, 1p?, C€Ü K K \$ í AäAŮ+^3£0 +^? +e()ç 1y6)í .ž P P +e 63' Ü K K \$ í AäAŮ+^? +e()ç 1y6 0 > P P +e 63' Ü K K \$ í AäAŮ+^? +e()ç 1y6 ?, AŮ P P +e 63' D) ;+Aä
	+> ? 0Á+et^ @zi AŮ5 8 +e,O, +^ @ZD) ;+Aä
	'», 0 .ZB» „ +e1h,) É*šD DB 4^(€-Ø „ É 6»», í =.9 +e*-^;(* í =.9 +e;ú5+;(5à÷D4 *^- D? 8Ň», A *^- 0 ? /T'», A *^- 2Z> A *^- =.9 D) ;+Aä
	*ÜB"1y6 +^3£0 +^? +e;5 8 =.9 *^- /T í B»» , 0 .Z6»DÉž „ í *Ü(f 8 +^? +e;5 8 1-B»B Ý / +> <AŮB +e8 6 *šD +e,p? 1T±=.9 D) ;+Aä
	B»=.9 ;5 @Š Ů K K+^4~) +dD10 Ü K K+> <AŮ 0Á) +d- 5 D 9Èœ+^4~*D+^ 63' +e;5 @Š^4~ (W, í BŮ°> 9í +^3£0 +^? +> <AŮ 0ÁÄ:) 4I,- 5 D) ;+Aä
	;5 8 =I A5O, +^4~+e;5 @Š^4~; í 5à-x*†+„B ,5 AÇ > <AŮ+et^ @ZV) AÇí .ž P 9D) ;+Aä
	;5 @Š í /Á<, É 9ÈÄñ+e/Ň É) AÇB (_<AŮ- 2Éí +^3£ 0 +^? +e2YB-) AÇAř6†< >:?: í +> <AŮe,0? ;à) AÇ *- *Š2YB-A5D#AŮ(.)ê A8†0' +eD) ;+Aä
	0 ?-8à,)		- /0

<Ö	0í @š 6 0' 0í @š 9)C4' 0 .)M1, .œ	0í @š, .œ
	63' AÇ@ÆE .\ +e0 ?-8à,) ÍA5 8E6¼ñ;="" DÑ ; Aäž)í D BÄ=+e0 ?-AÇG		- /0
	Aä=] < ; +eDÓ ;5 @ŠÑ\$5;58 1T±DÓ ;5 @Š		- /0
	1L;58 "" DÑB»A 3 P P/R Í)Á3 2ZB»> P P +e)D@ZEp Í)D@ZEp>ã4^(€m, B»¶ ?µ=q0¼p D		- /0
	A', ; 63' +e5 @š .m, ; 63' A @š +LAä%D[DÑD\$ < .m, B»D@ZEp D	.m, ; 63') ;+Aä
	8x9ì; 63' "" DÑB»A -x<ÛX6ÿ0 3Áç 0 ?-<1?µe)%4pD')ê+e0 E +e•)<6»Í B°Cœx.m, B»D@ZEp É 63') B»8E? AÇe" DÑM D15 @Š D 9Éœ AäÿÆÍ BÖÿÆ>i> +e,p? AÇšD AÜÓ +e ,p? D	.m, ; 63') ;+Aä
	5> .m, +e8x9ì; 63' ÍAÇä>, .m, B»8x9ì 0 E +eZB-p D	.m, ; 63') ;+Aä
	2ÉDÇm, +e8x9ì; 63' AÇä2ÉDÇm, B»0 E :p D	.m, ; 63') ;+Aä
	B»DÓ ; ; 8ÑÍ AÇäŽ .‡, D 9p÷D ,_ +e7E9 '2 +xE / .- Dôem, 5>, 7BÍ• D		- /0
	;58 AÇf@š DÑ +dDÓ +,,> Aû=l.ž;ADDB +e *šD 8 6 :p D ; DÓ B'0B' (Ž .‡, +eÄ,) 5E>ãD \$/ . % K P P & K P P ' K P P \$Í 8Ñ6) 0BÍ 'Ý3% 1Tµ ,÷ D % ÇžÄ"" DÑT Í *"" DÑŽ6 =* ? ,Aû P P É*' 8p< 8Qe2A3ì Ê+e) 0BÍ * 4l:p6 +e \$) ,÷ D & Í ÇžÄ"" DÑT Í *"" DÑŽ6 =* *ÔAû P P ,Y ,Aû P P É*' ' Í ÇžÄ"" DÑT Í *"" DÑŽ6 =* *ÔAû P P É*' 8p< 8Qe2A3ì Ê+e) 0BÍ * 4l:p6 +e \$) ,÷ D	P P	- /0
	>ã5EÄ,) 9, 2VÄú5 8 3ì"" DÑŽ6 E =*) ,÷ Í) ; 0' B»58 +e< Añ ,÷ Í * \$) ,÷ A5=f D		- /0
	;58 ;=+^+eDÓ ;(2ZB@e,÷) B»58 :p D8ã5E2ø) ; 0' DÓ D		- /0
	; 0'>ã4qDÓ Û K K,5Aú \$) 0BÍ DÓ *- Û *- B»D1?¥D;58 ;í 8 A', /T ÛB»D1?¥. (€B-0ÁB9Ö+e,-Ø *- Ûœ /T'2 ;58 9š< +e*šD AÜD@ZEt+eDB DĚŽ „ D /T Í B»ÁÇ +e+,-Ø *- D K K,5Aú %É;+Aä ÊÍ &/ . ') 0BÍ *- DÓ Û ') 0B B»D@ZEDĚŽ /T Í B»58 +eA)A6 DÓ *- Í (D÷)D@ZEt+e D\$ (...Í ;58 9š< +e*šD AÜD @ZEt+eDB DĚŽ „ D /T Í B»58 +e4ŽA)A6 DÓ 0 *- Û '2)D@ZEt+eš? ,Ö,p? DĚŽ „ Í,5;58 +e8E< 4^A6 -ØDÓ *- D		- /0

<Ö	oí @š 6 0' oí @š 9)C4' 0 .)M1, .œ	oí @š, .œ
	;5 @Š Í ;58 AÇ?(_) ,÷/ AF6»+e< /Ö DA6E(*Û +^) 0BAÇ A8\ (DÝ5 @Š *†0' D ,5 AÛ=f(Ž+e< /ÖA50') +]D#at^2A3ì0 +^8Y0Á>x 0Öz +e?, +e@Z/.) 0 ,5, á *†+^ (D/Á0 ,á D ;í +e Añ 1^9ì)[:>) 3ÜAÑ +e?, < 8 2Z2é/W55) 0Ş D) * Aäž 0' +e,æŒ Ö,7, / +e<ÖŒ>ãí CžÄ0 ?,,Cž44G <) 2ê0Û+e4r- í) 4H+i> Bx8à6,,;ý 0Œ0' 3Áç)%4p (Ž6 +e4r- 2êA5W55) 0Ş D	;5 @Š 5ÜAñ >÷: /Ö D	- /0
	A' , ; 63' B»] < ; .—SD 15 @Š	.m, ; 63') ;+ Aä
	2ê)Q? 63' 4MtD'BÍ)È.†, +e9í+^3É0 +^? ÍDãAé)Á,) *ÖB»> P P D) ;+ Aä
	AäŽ .†, D 9B;÷ D ,_ +e7E297B1•1t? ,, Dê+e5> , / . DŸ.5>, D) ;+ Aä
) 2ê)Q? +e 63' '• .J 0 DÖ•1^†±5 @ŠÍ+^3É0 +^ ? 1y,- D'5 * 63' B• P P)Á D) ;+ Aä
	;58 *' P P -À,) >ãED" P P /R+e- 'Æp í 5E>ã^ ;^> Û K K í 9Éœ58 D+4` É) *Û+^3É0 +^? Ê))í .ž JÜ K K í 9Éœ58 D+4` É) *Û+^3É0 +^? Ê)í .ž JÍ +L))í .ž JÜ K K í 9Éœ58 D+4` É) *Û+^3É0 +^? Ê)í .ž J D) ;+ Aä
	.—=SA5à,÷ D4 *^- +e;ú5+? ðEĪ ; ;58 5à,÷ D4>ãE *^- D5à*^- 1-A -x;58 B».—=SĐ1^†±5 @Š) ;+ Aä
	;5/T Í ;58 AÇÜAñ< /Ö Í A6E(Û K K9//) 0Œ) AÇ÷3ì0 ;ê, D K KAÇ 266½†0'9// *Û+^) 0Œ í 0•; Aä< DÝ5 @Š D ; 0') í .ž 1 +e4GA) AÇ†0' D) ;+ Aä
	B>5/T0Í)JD1Í ,5 9Í+^3É0 +^? +e4MtAÇ'1(DÄ ACDD A +^0 (D/Á) ;=AÑ ÍB<?Í Añ?, +e< 8 < 4r D) ;+ Aä
) 0Ö, 7at^2A3ì0 +^8Y0Á>x+e=f. < / / . ? , +e• /<2ê/W55) 0Ş D) ;+ Aä
	,3Á. „3Á+e 63' +e;5 @Š 1-B» ,Q>ã1^†± +e;5 @Š CžC-> 0Öµ-ØA *^- D) ;+ Aä
	,3Á. „3ÁÝ/ 2Ëy B<0Œ+e 63' +e;5 @Š '•)C4' ,æ+^+ @Ž < AñC4' +e+^ @Z D CžC -> 0Öµ-Ø *^- ? , AÛ 8SD) ;+ Aä
	„,3Á+e 63' +e;5 @Š '• 0 1-B» 8RF>ã1^†± *^- * 0 Í CžC -> 0Öµ-Ø *^- D) ;+ Aä
	9Éœ)C4' >ýD'+^ @ZnAÛ +i AÛ 8,Í BÖ58 =I.ž;5 @Š) ;+ Aä

<Ö	0í @š 6 0' 0í @š 9)C4' 0 .)M1, .œ	0í @š, .œ
	;58 4MtD",O, 8 5+/. E *Ô)÷?ÙEE +^ @Z8F+e+^ B•Í ;5 @š. @ZXD":z AÇ@ñ P \$+e,- 5 +^4~6½ 4GÍ * ,èD'BÍ)È<Â 4Ž=f+e+^4~D D ; 0' -+^B•; Û 4~.ž ;58 +^4~+eE ?μ,÷4' B»Cžó) - D *†)C 4') AÇÍ .ž P \$ D 0 *p0 .G/%B»0') AÇÍ .ž)C4' D +e D) ;+Aä
	2YB+^E		- /0
	(_;5 @š ;+Aä@Z@rB (D/Á1t+y4Mt+e1' ;U=f2è +e 63' D	;ý 4p=f2è) ;+Aä
	;58 9ÉAñž 0' +e1T# 2øÍ BÓQ# *ÓÉÛÉAñBä5E2øÍ BÓÓÉBÉD1A -x2øD²) 1%Ø[E.2@.6½Q?+e" /. 8E<) 0B9, >ä í 9ÉAñ(yA =M@ \$T#±6@Q;5 @š	>?-ž 0' 1T# 2ø) ;+Aä
)Ö; *†3Í AÇ»? ,5; ,) (D)÷> a +e)Ö; ? D11T#±D,æD\$58 *†+e2ö8Y>#,) (D)÷B» ç& a ç&D 0Á+e9^ A /0 ;+>#,) 7r ç&6»D;58 B»æ 9ì)Ö; ? D 8ÑÍ AÇ.9@ " 7/. É 7 É>#,) D 0ÁD ;58 AÇ»Ö; ? D1(D)÷ <Í É KÉ D	5+ ç&Í K	- /0
)Ö; ;5 @š 2 a P QÍ ; 0' 9+eD 4'+^@Z VT)C4' 2YB+^E	;5 @š^@Z 9' &	- /0
	² (\)Q>ã+e) 0B99ÉDÑ\$/T Í B»Ö; ? 0 B» ;58 *D+^ .†, >#,) +e,à 0Á3D1T#±)C4' D• >ã4qA 9 1T#±)C4' Û		- /0
	D B» Añ/Æ? 4Mt+e*Û+^) 0B9. 63' A87],\ 1t *†+e2è<Æ 0ÁD (_;5 @š/B Q2è<AR'Y 3%Û K K< Añ9A8†0' +e1' ;U) 0B9. '• CžÄ; Aä" DÑ /T2è*†0' +e2YB-) %4p(ž6 -" -" +e1' ;U) D K K"" DÑ63' +e8 6 í 9ÉAñ(yA í -+ (ž6 2è- -" 1' ;U) D K K² 63' .m, B»D 0½p+e5>, /. 8E< .E0B D ,5AÚCf?šC4' í 1' ;U) AÇf@š -" í ; 2è6½ÇB»e 6,,D'0BA ;=+^Añ?^ +e;5 @š 4MtD" 3(+e(D/ÁB<0B»_ ;5 @š 2è,02ÉD	? 0ÛÈ>ã	- /0
	E B» 63' D»^5 +e*Û+^) 0B9. -%D[+^5 +e*Û+^) 0B9É9ÉœAñ+eÑ ÉD 0ÁD 2YB+^E AÇ +rAûÛ 0 K K,5Aû DÈ? +e)C4' 1, .œí 0 K K,5Aû EÈ? +e)C4' 1, .œD	D B» Añ/Æ? 4Mt+e*Û+^) 0B9. 63' A87],\ 1t *†+e2è<Æ 0Á)C4' 1, .œ! 0 :	- /0
	1š+^8à,)		- /0
	/È=f; Aä+e 63' B»1t? ,, 0Á5 @š 6») 0B9Q>ã D B_ ;5 @š)í D1' • * %7 +e ,5 63' 7';í D) ;+Aä
	/È6»?@ 63' '• +e DÈ. EÈ< ;W1T#±5 @š	/È6»?@ 63'	- /0

<Ö	oí @š 6 o' oí @š 9)C4' 0 .)M1, .œ	oí @š, .œ
	'• (Ž Aä1\4~+^ @ž 63' 1 ^T ±5 @š2Ě ; +^ @Z))Í .ž < A 9 +e1\4~+^ @žeA 'ì Í9œTB» V6»Bx 0'D'90Ď Í) (D)÷ P IQD		- /0
	D B» Ař/Æ 4Mt+e*Ú+^) 0B. 63' A87],\ 1t *†+e2è<Æ 0ÁD (;5 @š/B Q2è<ÆR'Y 3%Ů K K< Ař9»A8†0'+e1';U) 0B. '• CžĀ; Aä" DŇ /T2ê†0'+e2YB-)»4p(Ž6 -" -" +e1';U) D K K"" DŇ63' +e8 6 í 9ĒAř(yA í -»(Ž6 2ê- -" 1';U) D K K'^ 63' .m, B»D 0½p+e5>, /. 8E< .E0B D ,5AŮCf?šC4' í 1';U) AŮCf@š' -" í ; 2ê6½ÇB»+e 6,,D'0BA ;=+^Ař^+e;5 @š E B» 63' D×^5 +e*Ú+^) 0B. -%D[+^5 +e*Ú+^) 0B É9ĚœAř+eŇ ĒD 0ÁD	8F 9DF D B» Ař/Æ 4Mt+e*Ú+^) 0B. 63' A87],\ 1t*†+e2è<Æ 0ÁD)C;5+^ @ž Ů	- /0
) AŮĀ :> b5H. 0 *š Í 9œY9ĚœB»æ+^; +^ @že(... /Đ?, AŮ í 2êB«Í27) ,æ+^ D	5ÜAřĀ :> b5H. 0 *š	- /0
	-%D[+^5 '• * % 1 ^T ±5 @š	>?-%D[+^5) ;+Aä
	,áD .m<ÆP1TŮ]/. ;ĭ +eAř 1 ^T Ů		- /0
	'• Cv * % 1 ^T ±5 @š ?,,/, ,3*Ů5LD	,3	- /0
	6©©		- /0
	63' B»#,) > „ &a . +e0'9œ D1(D)÷ K	„ &í K	- /0
	6») E DŇe9 // 5ý- /Đ/0>P) AŮ~*	>?5ý- +eĐ/0>P4~*	- /0
	3Á9•/T í ;58 '• CžĀ; Aä<ŮB"" DŇ AŮ 2ê6½†0' 9~// *Ú+^) 0Bí 0•; Aä< D'Ů ; 0'A -x))Í .ž 1 +e4GA) 2ê†0' D0•; 63' +e=3í8X02ĒÍA 2ê9° > 63' A2=I.ž ;5 @š	=3í8X> , E	- /0
	63' D1Až2YB-)»4pD')ê+e=f) 4,,0BAä=] D/. =] E < ; +e;5 @šŇDŠ1 ^T ±9 @ž @š		- /0
	2YB-)»4pD')ê+e^2 B'4~) 0B. 1t+y+^5 +e) 0B(D)÷B»8E> D\$P (y ?ì+e=f) 4,,0Bí B»A -x>#,) > „ &a . +e0'9œ D11 ^T ±5 @š	9 @ž @š#,) Ů „ &	- /0
	2YB-)»4pD')ê+e) ;(' 2 B'4~) 0B. 1t+y+^5 +e) 0B(D)÷B»8E> D\$P (y ?ì+e=f) 4,,0Bí 0•; Cf?š4,,0B B < 5ê? 1t*† í ;5 @š» „ &a . +e0'9œ D11 ^T ±D ?±D) ;+Aä
	'2 ;58 ;++R+y.m, í ; 8Ež6 *†AŮí 8 > D\$í '2 A -x>D 2 P P +e- 9 Aä 1+e4G@Z-(ž6 D KT í '2 -- 9 *' ;58 :pA'2ĒÍ 9œ'2 ;58 1'Ůì3Á ;ĭ D† 8EB» V6»3Á9•D'Ů2 >#,) D		- /0
)C4` Aê- 9 ?'ê+e@ž D 2) AŮí .ž P P	4')C+eE *Ů@ž P P	- /0
	@š +^8Y0Á»x. 7a+^2A3ì		- /0
	9~, +^8Y0Á»x. 7a+^2A3ì; í) 2Y5(,æ+^0Á»x+^0œ D 0Á+e2A3ì D		- /0
	/Ē=f?© 63'	/Ē6»?© 63') ;+Aä

<Ö	Óí @Š 6 0' Óí @Š 9)C4' 0 .)M1, .œ	Óí @Š, .œ
	*Û+^) 0ß. +yD 0Á+e+^8Y0Á>×. 7a+^2A3ì) AÇ, AÛŽ .‡, +eD) ;+Aä
	/È6»?@ 63'		- /0
	+^8Y0Á>×. 7a+^2A3ì) AÇ, AÛŽ .‡, +eD Û +^8Y0Á>×É P P Ê	8F 9DF	- /0
	Ê) =MÖEe*Û+^) 0ßD 0Á	P P ! P P A 9 D	- /0
	Ê*Û+^) 0ßB K K"" DÑ63' ; (y ?ì)Q?+e.m, -" +e5>, 0 8E< .E0ßD 0Á) ;+Aä
	K K"" DÑŽ6	P P ! P P A 9 D	- /0
	K K"" DÑ63' +e5>, 0 8E< .E0ßD 0Á) ;+Aä
	K K2è<ÆD 0Á	P P ! P P A 9 D	- /0
	Ê=r3ì 8X0 .Z+e1';U) 0ßB K K2è<ÆD 0Á) ;+Aä
	K K"" DÑ63' +e5>, 0 8E< .E2@) ;+Aä
	7a+^2A3ì É P P Ê Ê) =MÖEe*Û+^) 0ßD 0Á	P P ! P P A 9 D	- /0
	Ê*Û+^) 0ßB K K"" DÑ63' ; (y ?ì)Q?+e.m, -" +e5>, 0 8E< .E0ßD 0Á) ;+Aä
	K K"" DÑ63' +e5>, 0 8E< .E0ßD 0Á) ;+Aä
	K K2è<ÆD 0Á	P P ! P P A 9 D	- /0
) 1t+<Æ50' 4MtD'Bí)È.‡, +eE *Ô1y6 0 +e+<Æ í)C4' +^8Y0Á>×. 7a+^2A3ì D0°, 5>6T", èB" =X>, 7B1•B»E) 3Û+e> D\$	A22Y5(- /0
	9Èœ1';U) 0ß\ D":z P P /RDöAÇµ+e;XD -" -" í 0 9Èœ6¼ñ;= +e;5 @Š @Zè2YB-" -" í BQ ?ÉA)C4' 7a+^2A3ì/. +^8Y0Á>×D	>?*-3Á1';U) 0ß) ;+Aä
	<ï* >P) AÇ[.ž)<2ø+e(€B-Í, YAÇ. m+y-ž DaB»< 2ø(0' 8ED1+e1';U>P.p) ;+Aä
	6 Óí/.) ; AäE2@5=]ß 3ì <ï* >P) ;+Aä
	6@^/</Ð	0ÜÈ>ã) ;+Aä
	; B'4~) 0ß(D)÷B»8E> D\$p< (y ?É+e2YB-) %4pAÇ ;(6@^/</Ð) %4p) ;+Aä
	,5<T" a D'E +e2YB-) %4pí 0 7a+^2A3ì D":z +i Aû .‡, D +e (W í (;5 @Š ;+AäD	-Ú2> ;5 @Š C4' D í 7a+^2A 3ì *ÔAû‡, D +e (W í (;5 @Š ;+ Aä) ;+Aä
	;5 @Š Aä * %7 9/A \$ í ;5 @Š @Z 9D) ;+Aä
	6@è CžÄ9@. 6@•	0ÜÈ>ã	- /0
	Dç@à ;5 @Š * %7 D1+{ D" <Ö B> >ã4q<Öß>ã1T±Û		- /0
	K K,5 Aû 63' D'Aä2YB-) %4pD')ê+e² B'4~) 0ß. (D/Á+^5 +e) 0ß(D)÷B» D\$p(y ?ì+e=f) 4,,0ß í ;5 @ŠÇ» q& r .>#.) >ã1T±D	;5 @Š#) q&D	- /0

<Ö	0í @Š 6 0' 0í @Š 9)C4' 0 .)M1, .œ	0í @Š, .œ
	K K,5 Aú< AñAè2YB-) %4pD')ê+e8E< 4,,0BÍ ;5 @ŠÇ B» q& r .>#,) >ã1T±D 2. (_;5 @Š @ú8 6 "" DÑ 63' +e0 E 2è2ÇE ;(=f) 4,,0B D ,5 <Tª) %4pD')ê+e) 0B) 1T±(_;5 @Š 9Èœ2YB-0B;(Aê=MA D7%4pD')ê Í BÚ -,5 8ED1A -x 4,,0B• ? AÇ-eDç@à;5 @Š#,) 1T±5 @Š) ;+ Aä
	;5 @Š; 0ÁÍ ;58 *†AÜE†, ; Aä+eE) 3Ü+e> D\$ É(\ ;5) 0B+e(Ž6 *†AŮšD > D\$É D		- /0
	2Y5(0' 9Ç<0B0 Dçç<0B2è6' B ;58 1t*†+e; Aä <ÖBÍ Dçç@à+e, ,, AÇ 0' B»58 .†, +e(Ž6 :p D		- /0
	9Èœ /0>ã4ç<ÖBÍ ;58 2è2ÇE =l.ž 4l Dçç@à;5 @Š K K5ÜAñ2è0Ü+e0 @†)÷?Ù .f Í 0 K KDçç@à A' 2ËT;58 :p+e0 @† 0 .f B» V6» Dçç@à ÉB D	Dçç@à A' 2ËT;58 :p+e0 @† 0 .f B» V6»Dçç@à ÉB D	- /0
) AÇ,,9•(B5yD 0 :v 1Zê 6YÆD	5ÜAñ,,9•(B5yD A 5ÜAñv 1Zê 6YÆ	- /0
	/Ø2 A 9	/Ë6»?@ 63') ;+ Aä
	/Ë=f?@ 63' AÇÑñ 4HÇp Aõ+e<Tª 0 8E< 3ÁÇ)% 4pD'E +e6ÇYS,á /ÁÇWÍ A5á D Dè=f? - :...C•; /. +^ /< /Ø D) ;+ Aä
(YDÄÚ			

<Ö	óí @š 6 0' óí @š 9)C4` 0 .)M1, .œ	óí @š, .œ
;5 @ŠÖq			
	,_, 2Ů. ;E9ì ;E* ,, Dô÷2Ě+eA ,, 2û+e 63' ;5 @Š	A ,, 2û 63') ;+Aä
	9~, +^@ZV^ ÷(i +e;5 @Š) ;+Aä
	B»E9ì ,, ; 0' +^@Z8Fí) AÇD, B» 6»D5 @Š ; ,O, -> B1+^4~4~.ž E ?µ> B1 Í=M B»Mt-> B1;)C4` ;E9ì/. ;E* +^@Z, A»ã4qL; 9~, +^@ZV^ ,÷(i D ' 8 >8;E9ì !š 8;E* 8;E9ì @) ;+Aä
	AÇ`5 -æD) - /0D'Bí)Ě+e.†,) ;+Aä
	-> B1)A+^Aæ@=6¼G	A ,, 2û 63') ;+Aä
	1-;+AäAŮî/Ě:š)ç+e,_, 2û 63') ;+Aä
	,5 (_;5 @ŠT±Ú K K * +^4~) * 0 Ü K K0 * -/0) * 0 Í 2Ě +^@Z 8RFD) ;+Aä
	,5;58 +e;E* ,, 2û; 0' +iAŮ'Bí)Ě.†, +e> B1)A +^Aæ@=6¼G +e* 0 Í* 0 ,÷)ê E Í5äE * D Aä()ç+^4~D":z> \$+e+^B•,5 63' ; 0' 8FD5ä * * 0 AÇ +^B•8 5+=M Í=M 1hAÇ' ,, 1h2Ě Í A5 ,, a ,, +e0ÁÖDQ-Bx' D) ;+Aä
	4^* * 0 D 0Á+e0ÁÖ; 0Á> Va Ví 4^E D 0Á +e0ÁÖ; 0Á> P IQa P IQD) ;+Aä
	Cœ;5 @Š)í D1Í ;58 AÇ 0' +^@ZAÇ`5 ;E* ,, Dâp+e+^@Z) ;+Aä
	/0-Ö7q((< DÝ	A ,, 2û 63') ;+Aä
	5ä* * 0 /T, 6½D+^9@),) ;+Aä
	9~// ?Ů~, 6¼DöÉ) ;+Aä
	+^@Z +^4~) ?=]0' 6)C0í)J;58 AÇÜAŮ *Š0 :b5H+e÷?) ;+Aä
	B»5 @Š)í D1) AÇÁ: 0 ?-< /Ö) ;+Aä
	Aä()ç+^4~6¼G":z> \$+eC+^@Z 8F+e+^B•J+^Í ,5 63' AÇ^; 0'A * ,Q 8RF +e* 0 Í B* 0 /T Í (D)÷ 8F P IQD 63' AÇD+^ 9@), D) ;+Aä
	A +J*D+^9@), Í 1T±>ã4q)C;5 Ú K K)C4` 4~.ž;58 +e+^4~ Í 8EE ?µ÷4~ ÉB»Cž>ó) +e D *†)C4` Ě AÇÍ .ž P \$ 0 K K*P0 .G/%Bx 0') AÇÍ .ž)C4` D +e B»CjCœ;5 @Š ?ÓTA5' ;58 3Á9•+^1t1•/Ø2 ># ,) A5T Í AÇ9• ;5 @Š ?ÓĚ ; < 1T±+e)C4` >ýD' +^@Z @Š) ;+Aä
	,3Á. ,,3Á+e 63' +e;5 @Š 1-B» ,Q>ã1T± +e;5 @Š CžC-> 0Çµ-ØA * D) ;+Aä
	,3Á. ,,3ÁY/ 2ĚyB•0ß+e 63' +e;5 @Š ')C4` ,æ+^@Z < AñC4` +e+^@Z D CžC -> 0Çµ-Ø * ? ,Aû 8SD) ;+Aä

<Ö	oí @š 6 0' oí @š 9)C4` 0 .)M1, .œ	oí @š, .œ
	„,3Á+e 63' +e;5 @š '• 0 1-B» 8RF>ã1T± * * 0 Í CžC -> 0œµ-Ø *~ D) ;+ Aä
	;5 @šŃ. ;5 @š<)C4` +e+^ @D ?, AŰ +i Aû 83) ;+ Aä
	Aä .‡, +eE ?, 1y6 +e+^3ÉÍ B»Ø2 >#,) >ã• +eA 9 ,5 63' =l+^ D-> B1+^4~AÇœ > D' BÍ)È< .‡, +e,O, -> B1+^4~ D) ;+ Aä
	9Éœ-f2ê*Đ+^9), Í 8óB»CžÄ" DŃã2ê*†0') 0ß +e#,)) Í .ž;36»Ø2 >#,) . É0Ü É Í BÓ 63' ;5 @š-Ø D) ;+ Aä
	.ž B1?µ6½	A ,, 2û 63') ;+ Aä
	(_;5 @š» Añ+e,_, 2û 63' :p 1T±D,5A ,, 2û 63' Í 1-B»E9Í/. ;E* ,, DŰÄMt? +e1y6 0 ?, Aû ;5 @š, +e+]? ;)&AÇT±(_;5 @š) ;+ Aä
	;5 @š»Ø2 >#,) >ã1T±Í) 8ó;5 8 AÇ} 6 AMÄ+e=f) 0'9@ 3Ä9• D) ;+ Aä
	;5 @š'5 /.) DIAÇÈ < ;WÍ * 4l+^5) ;(DX +^5 /. (_;5 @š 0š>#ž=f D) ;+ Aä
	1T±5 @š) 4Mt9^-// =f) .ž +^4~(D/ÄDŃÉ6» 2êA' * +ež +^4~(D/ÄDŃÄA -xE 2Úê/W55) 0š +e4Mt*Ú<ÇÈ D) ;+ Aä
	9ÉœD'BÍ)È.‡, 4l E *Ōž +^4~(D/Ä Í 63' AÇ-IA5+i AûE *Ōž +^4~(D/Ä . (W+e+^4~-> B1 KD,5 AŰ(D /ÄDŃÉœ(,05 8XÍ . D 9, 9Éœ(9¼08XÍ . D 9, D) ;+ Aä
	9ÉœD'BÍ)È5ÜAñ‡, E *Ōž +^4~(D/Ä Í 63' AÇ-IA5 (W0, -> B1+^4~ KÍ0 D"6») +e=r3ì8X E D 9ÉœB» K6»5ÜAñ=r3ì8X E Íá?;, 1L>é8Ń+e;5 @š'4~B»D" (W0-?Ú5 @š D D"6») =r3ì8X E D) ;+ Aä
	/0-Ø7q' (< DÝ) ;+ Aä
	B»5 @š)Í D1Í 2ê1t*†+e(Ž6 +e#ž AÇŰ(+nAû . D) ;+ Aä
	D 5ÜAñ6») =r3ì8X E K K6)CÓ)J;58) AÇ >÷9^-// < /Ö+e,,? K K,5,á/Ä+i0-*ŌAŰ +iAû ,3 +e 63' Í ; Aä(< DÝ5D; 0' 1 +e4GÉ0Ü * % É) AÇ† 0' *Ú+^) 0ßÍ * 4l 63' '• CžÄ; Aä" DŃTB»5 @š 8ŃA22ê*†0' +e*Ú+^) ,÷=f D K K9œT'2 ;58 4MtD" 8FÍ ;5 @š. @BXD":z AÇ@añ P \$ +e- 5 +^4~6¼GD)C4` 4~.ž;58 +e+^4~ Í 8E ?µ÷4' ÉB»Cž-ó) +e- D *†)C4` É) AÇÍ .ž P \$ D 0 K K*b0 .G/%B»0') AÇÍ .ž)C4` D +e D) ;+ Aä
	,3Á. „,3Á+e 63' +e;5 @š 1-B» ,Q>ã1T± +e;5 @š CžC-> 0œµ-ØA *~ D) ;+ Aä

<Ö	oÍ @Š 6 0' oÍ @Š 9)C4` 0 .)M1, .œ	oÍ @Š, .œ
	,3Á. „3ÁÝ/ 2Ëy B<0ß+e 63' +e;5 @Š '•)C4` ,æ+`+`@Ž < AñC4` +e+`@Z D CzC -> 00Eµ-Ø *` ? , Aû 8 ₃ D) ;+Aä
	„,3Á+e 63' +e;5 @Š '• 0 1-B» 8RF>ã1T± *` * 0 Í CzC -> 00Eµ-Ø *` D) ;+Aä
	9Ëœ)C4` +e+`@D ? , Aû +i Aû 8 ₃ Í BQI.ž (;5 @Š) ;+Aä
	-%D[+`5 Í 9ÈDQ•D ; 8XÍ AÇ†B»CžÄ.EE DQ• D) ;+Aä
	4Mt Añ-r3ì 8X+e 63' +e> B')A,- 5 6@=6¼4G5 @Š	A ,, 2û 63') ;+Aä
) , - 5 9`/ B<0ßÍ +LAä .† , +eE *Ô1y6 0 0' P P)Á+e+> <Æ 5 < Añ+e> B' , DóI D9• +e;5 @Š) ;+Aä
	/0-Ø7q' (< DÝ) ;+Aä
	;5 @Š Í +`B•+e,- 5 +`4~AÇ» V6»,02ËD;5 @Š)í D1Í (BD 0 :U)) AÇ•:v Í *~=fÍ AÇ 0 ,59- B'0 :%(Y)[: (MCI0 8E< > >ö D) ;+Aä
	2ê†0' 63' Û) ;+Aä
	;5 @Š Í ,3+i0-+i Aû *ÔAû ,3 ; +e 63' Í Až< DÝ ;5 D ; 0`A -x 1+ø4G0Û * %) AÇ†0' *Û+`) 0ßD) ;+Aä
	9Ëœ5ÜAñ») +e-r3ì 8X E Í 63' AÇ[E +eA 9 D) ;+Aä
	;58 '• CžÄ; Až-Öß" DÑI 4Mt .† , +eE ? , / E *Ô1y6 0 +e+> <ÆT±;5 @Š) ;+Aä
	(< DÝ5 D É' * % È,æB»5à-x2ê6½††+`+e> D\$D) ;+Aä
	,5AÛF9ì; 63' É) ; AäE2@.2ê-Ý/Û É Í +RF=X) , ÷ +y)F9ì 0 9Q)F9ì)FE ; Í ;5 D ,æB»5à-x2ê6½ 1t††+`+e> D\$D) ;+Aä
	; AäA -x+`@Z +nAû 9/ .) -ÄAû 9+e+`8YD ; 8X3>ã; B Añy) 0ß1t†† D) ;+Aä
	,3Á. „3Á+e 63' '•)C;5 D) ;+Aä
	,3Á. „3ÁÝ/ 2Ëy B<0ß+e 63' '•)C;5) ;+Aä
	„,3Á+e 63' '• 0)C;5 D) ;+Aä
	A ,, 2û+e 63' AÇ =l+` ;5 @Š) ;+Aä
	, „, 2û+e 63' AÇ+l+` ;5 @Š 8E+`B•+`@B» 8F ; +e(<)ç +`4~D":z \$D) ;+Aä
	,5AÛ@Añ†? „, Dê+eA ,, 2û 63' Í 1T±;5 @Š 5Û Añ=f1t=r3ì 8XÍ B», Dâp)C4` >yD'+`@Z,5AÛ@ñ 4Mt+]? +eA ,, 2û 63' Í AÇ»8E=f1t+]?)Ä,) > P P >â)C4` >yD'+`@Z) ;+Aä
	,5AÛ_, 2û+e 63' / . 2@ñ> B'1†? „, Dô÷2Ë+eA „, 2û+e 63' Í B» 63' +e> B' , 2û0 -> B'1†? „, Dô)C4` >yD'+`@Z) ;+Aä

<Ö	óí@š 6 0' óí@š 9)C4' 0 .)M1, .œ	óí@š, .œ
	>ÿD'+^@ž ? AÇ;e;5 @š-(1 ^T ±;5 @šeE -À+^@Z D D) ;+Aä
	Aä * 0 +^4~)C4')1 @Z) ;+Aä
	'• A5ã- D +^4~)C;5 Û ,Q ,Q ,Q ,Q) ;+Aä
	,5 63' ; 0'A -xCžœµ/. A -x-→ œµ?Óq D) ;+Aä
	E /T 9Ëœ P D 0 SHDN *ÔÂû òÍ BÓD":z,5 63' ; 0'A * P D 0 SHDN * 0 +^4~ Í +^4~ œµ> 8Ñ6 ;5 @š)1 @žp*Ô+œœµ D) ;+Aä
	5ä*- * 0 +œ0ÄÖ; 0ÄAÇE A5 ;5 8 3Ä0•+^/Ø2 ># ,) D) ;+Aä
	5ä*- * 0 AÇ'5 +^4~/. +^@ž ?- =] D) ;+Aä
	0)ê,æ+^4~B)1 @žey >Ö ? =]) ;+Aä
	2W >ÿD'+^@že)1 @žê-ã4q+^4~,x > 6»? AÇ ? +eE -À+^@ž 3•9~, Û K K ,3ÄÛD +^ SHDN 0 òÍ 9, 1p*ÔD Û K K ,,3ÄÛD +^ ,QD) ;+Aä
)C4') 8Ñæ+^+@Z) ;+Aä
	; Aä * 0 +^@ž ,Ä: 8X2Ë5 ;E* +^@žœ > N9D) ;+Aä
	,5 63' ; 0' *- * 0 Í Cž> œµ-Ø *- D) ;+Aä
	5ä*- * 0 +œ0ÄÖ; 0ÄAÇE A5 ;5 8 3Ä0•+^/Ø2 ># ,) D) ;+Aä
	9Ëœ 0'+e *- * 0 D1+e9^A *- 5ÜÄñ)M+^B») 8Ñæ+^ Í AÇ ,Ä: 8X+e2Ë5 ;E* +^@žœ > N9Í D9• :p;W;5 @š) ;+Aä
	Aä) 8X'5 63' :p+e+^@Z) ;+Aä
)C+d+e>ÿD'+^@ž Cœ;5 @š ?ÓD1+eE *Ô,æ+^+ @Z) ;+Aä
	Aä• /0))C4' >ÿD'+^@Z) ;+Aä
	-• /0) AÇ 0'B»=I+^+e 63' :p Í 8E+^B•+^@ž 8FD) ;+Aä
	1-AäÄÛ\4~+^B•>Ö-T+e 63' Í B>Cž>ó+^@že „ a „ ? > *‡; 0'Cžœµ* 0 ÍB» „ a „ ? > *‡; 0'-> œµ* 0 D) ;+Aä
	AäÄÛ 4~>Ö-T+e 63' Í; 0'Cž> œµ+e* 0 D63' AÇ 0' 8F +eD 4~+^@Z) ;+Aä
	5ä*- * 0 +œ0ÄÖ; 0ÄAÇE A5 ;5 8 3Ä0•+^/Ø2 ># ,) D) ;+Aä
	:œ -• /0) ,Ä: 8X+e+^@ž ; ;E* +e2Ë5 +^@ž 8F 8F 8F 8F) ;+Aä

<Ö	óí@š 6 0' óí@š 9)C4' 0 .)M1, .œ	óí@š, .œ
	5àD7 D ,5 63' ; 0' * - * 0 Í Cz> 00Eµ-Ø * - D) ;+Aä
	Aä) 8X0"5 * ,Ä: 8X4"9ì 63' +e+^4"/. B» 63' ;E* ,, 2û+e+^@Z) ;+Aä
	>yD'+^ @Z BxCœx;5 @š ?ÓD"10"5 +eE *Ô- D +^ @Z) ;+Aä
	9ËœA -x 63' 6») +e=r3ì8X E Í AÇñ6 >õ+eC Añ?^/. A2\$,02Ë+e0,,? D Bxóí)J,02Ë í) * 9, >ã4q) DI Û D 9"9";E* ,, 5ÛAñ+^ @Z E B»? AÇe;E9ì,, Dð. ;E* ,, D0A 0'+iAù (W 8F+eE8 +^@Z P LÍ) AÇñí .ž P \$ Añ ? D +e+^4"4".ž D) ;+Aä
	;5 @ŠÇY 3% AñD' BÍ)È:š 6 +eB 63' * 4K+e%D[) 0B D) ;+Aä
(YDÄÛ			
<Ö	óí@š 6 0' óí@š 9)C4' 0 .)M1, .œ	óí@š, .œ
;5 @ŠÖ1q			
	DÛ•D ; 8X+e, E		- /0
	BxCœx?@ ;5 @š)í D1Í D ; 8X< >õ; +eDÛ•AÇ >[+y-Û* B D ; 8X4Mt) ,÷+eDÛ•+e(D D5 *ÛAñ .ž, +eD10ÁDÛ•D ; +e 63' í) 6"9"> D10ÁDÛ•; (D ; 8X+ek CpD+RñAAÛA D7DÛ•D ; ,p; ; í 3p 9Ë_0 +e/ A 2û+eD ; í BÖàD7?@ +eD ; 2ZAÇÍ)J DD' BÍ)ÈAÇÛ* .y AÛ ; 8XG6%A5' DÛ•D ; (... /D/T <) * 9, *ì ; +e?!>ÄD		- /0
	DÛ•D ; 8X2âAê_) ,÷E)è í Cf,_) ,÷AêA -xX•/0 0 .Z4Mt í X•/00 .Z2âA5(0 ?-+eí .f @Heí AÛ +e/ .+^*! +e+ DB»Ý/Û 63' ; (\ -Ý/Û+eCfA) ,÷ í AÇËp< ;W;5 @š B»Ý/Û 63' ;) -Ý/Û+e4ZA) ,÷D":z AÇ1Bx0' * -): E D) ;+Aä
	X•/00 .Z): E DÛ•D ; 8X) -Ý/Û) ,÷+e, E 2âAä 8E< ,p,É3•6,,6Áí3p9ÉíA -x,÷2Ë+e+^*! <Û +Fê í ,Y) Aä: E 63' +e2ê-Ý/Û) ,÷4,,0B+e,p,É D) ;+Aä
	+R5 <) * Aä+eD ; ?@ Añ0;+e(DÝ í DÛ•D ; 8X+e,è-Ý/Û) ,÷AÇ /0Cf×(DÝí * 4l D ; 8X1-?É A * -): E ;5 @šf D) ;+Aä
	,÷2Ë+^5 D 0A+eÖ3ì) ;+Aä
	+R 63' Ý/ A -xB DX^5 +^8Y:p-Ö3ì+e+^5 ; í D' BÍ)ÈAÇ-ÁJ .y Aù+^5 D 0A-Ö3ì/. 2YB-6@=+^ @Z +e?!>Áí 0' D' BÍ)È:š 6 - /0 +eAñy (DÝD) ;+Aä
	9ËœAñ_-x A5p+e+^5 ; í AÇ5 5â-x+^5 +eE /01™ ?±Ö6 D) ;+Aä
	,÷2Ë+^5 D 0A+eÖ3ì/. 1Š+^8à,) AÇ D' BÍ)È+e;Ö 6 1T?±5 @š) ;+Aä

=] K K, E -> B^{1+e}C;5:%D\$

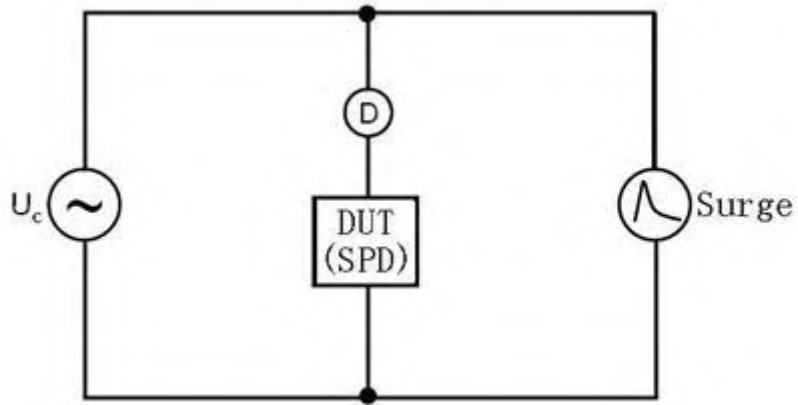

8F.E8 +[^]B•
 6XU HÛ ,IP SC ,P D[C ,Q. 8RF
 ' ÛD'BÍ)Ë:š)ç+e 63' +e=f) =r3ì 8X
 ' 87Û)C;5 @8



)C ;5 :%o(Y 9 +F

:%(Y6)ç	D'Í)È	?@& .‡-Ò	:%(Y(• /&	?„D'Ÿ¶8;	Ař?°9¶8;
* 0 +^4~ ,Ã:› 8X	:p/ .{ =]	* ,& ' &	/13 6%		
,A.G61\4~;5 @Š ^ˆ B•	:p/ .{ =]	72 9/+	/13 6%		
1\4~ , E -> B¹	:p/ .{ =]	* 3\$&	/13 6%		
6@X;5 A(:p/ .{ =]		/13 6%		
/D>#D; ;5 @Š	<Í/ D-Í	7+	/13 6%		
/Ü8Y; 3°/Đ?	<Í/ D-Í	7+ \$	/13 6%		
D@à;5 @Š	<Í/ D-Í	7+	/13 6%		
5 +^8Q<;5 @Š	<Í/ D-Í	7+	/13 6%		
9 @ž @ŠŃD\$	<Í/ D-Í	7+	/13 6%		
\$ 3Á5 @ŠžŒ	<Í/ D-Í		/13 6%		
%3Á5 @Š.D	<Í/ D-Í		/13 6%		
/&5;^ D+^8æ	; 3ÜA(8X	9& \$	/13 6%		
/M=f>#,) 0\$	-„ 5 2ì)/8. (/13 6%		
7E4G>;à+W	<%†2È=y	(; 3/2 ,7	/13 6%		
=“AäŽ	-„ 5 2ì	%	/13 6%		
8E?~ (Ž	AaÜ+c	87 \$	/13 6%		
;^>ö2È	.‘ 4w„ 5		/13 6%		
=gž4G\$	'• +c(E	1.	/13 6%		
6 (Ž	<Í-„	3&	/13 6%		
; D4	(R0E“	\$	/13 6%		
># ,) 0\$	+d4G•=f		/13 6%		
># ,) 0\$	+d4G•=f		/13 6%		
># ,) 0\$	+d4G•=f		/13 6%		
'» *TM 0 ;5 @Š	„ D>D(4G-l	%&	/13 6%		
Cž>=Š	?£, /Đ.E		/13 6%		

-ž5
Cž00µ>ÿD'+^@Z

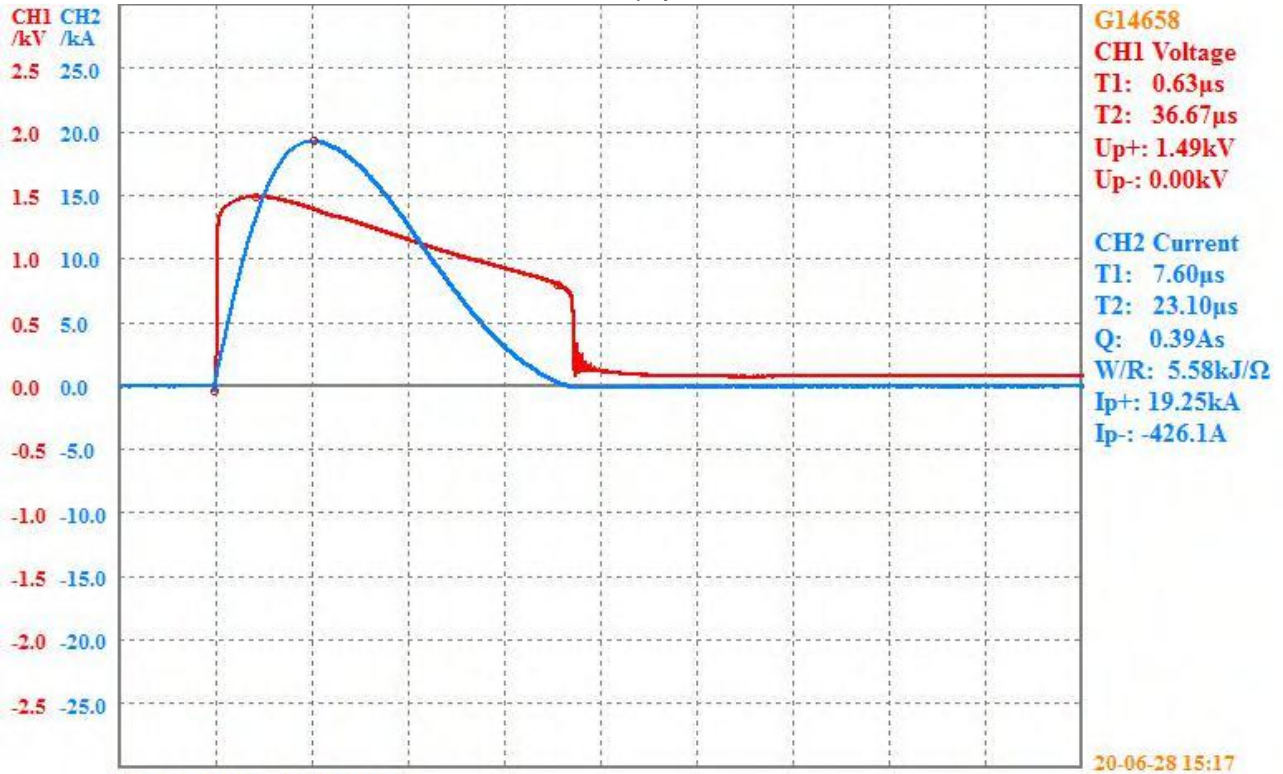

-ž5
-> 000µ>ÿD'+^@Z

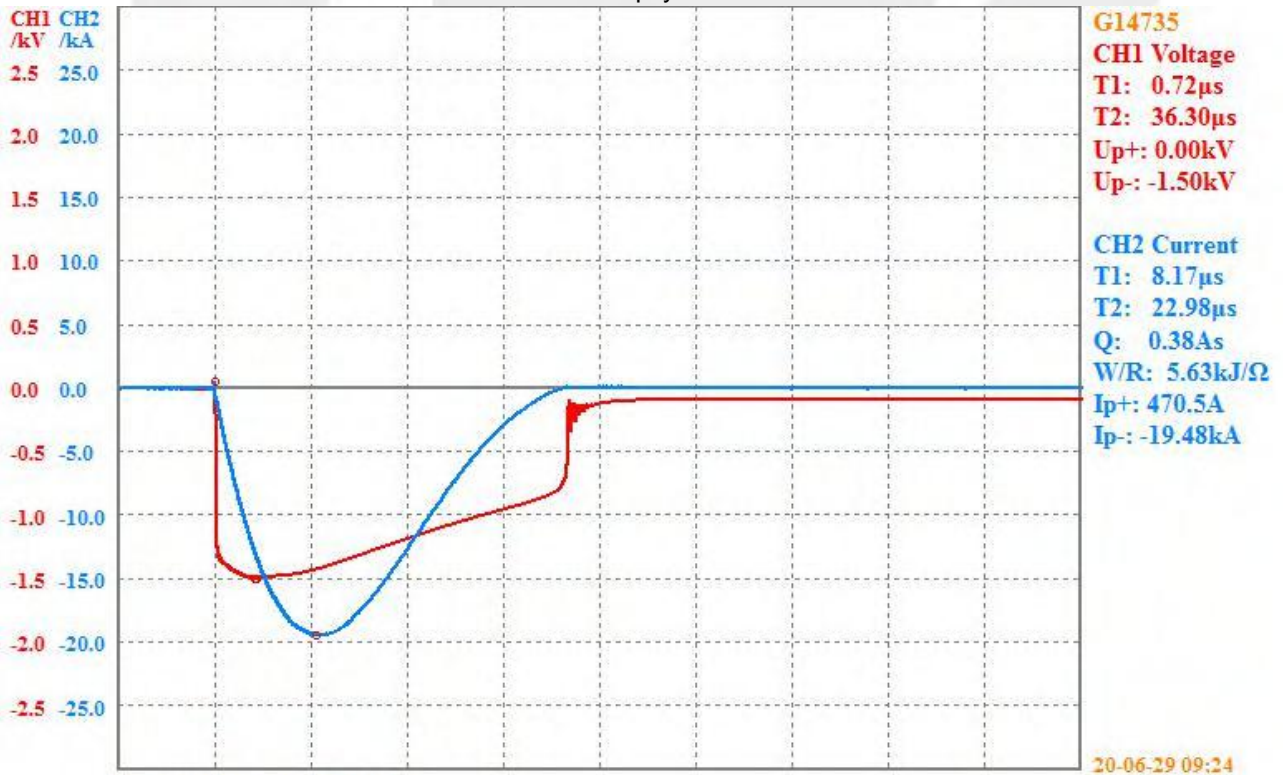

-ž5
E *Ô,æ+^'4~ ,P D[

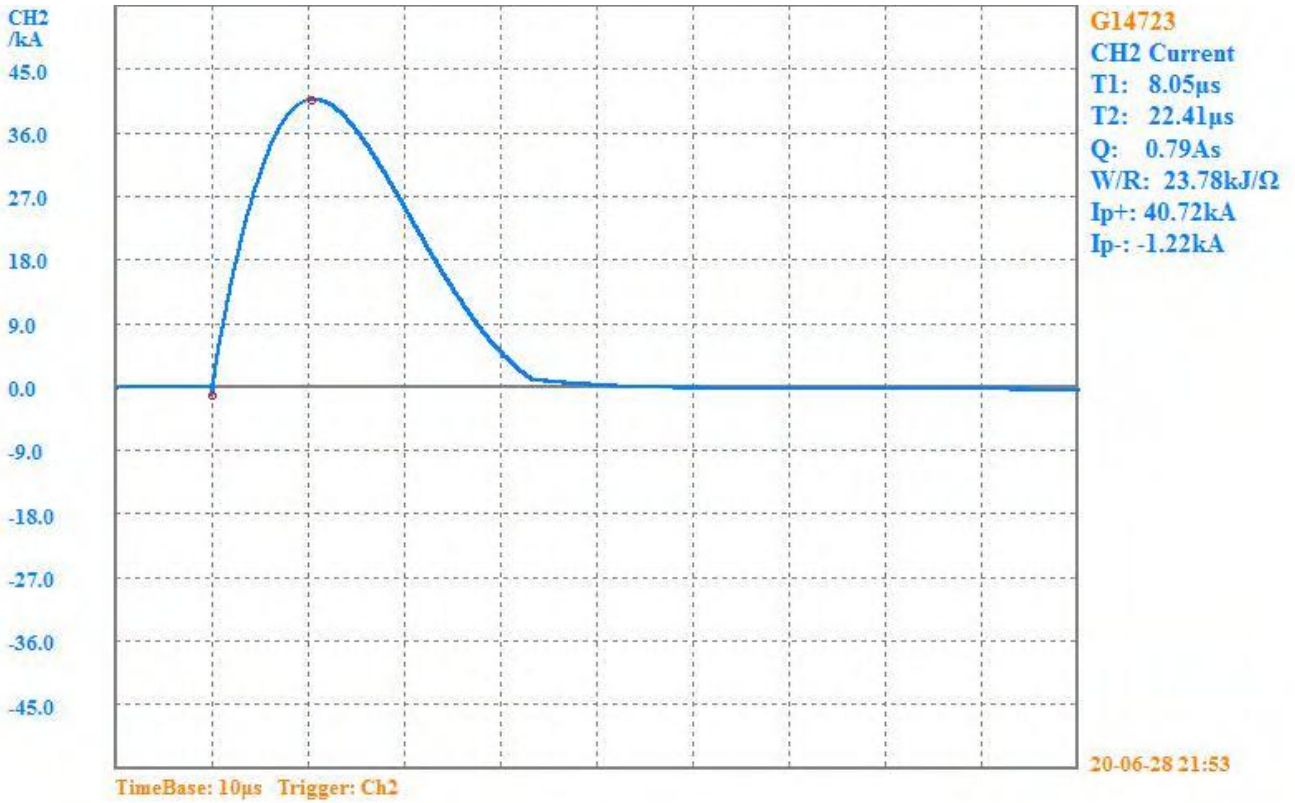

-ž5
9⊙), ?µ5 @Š

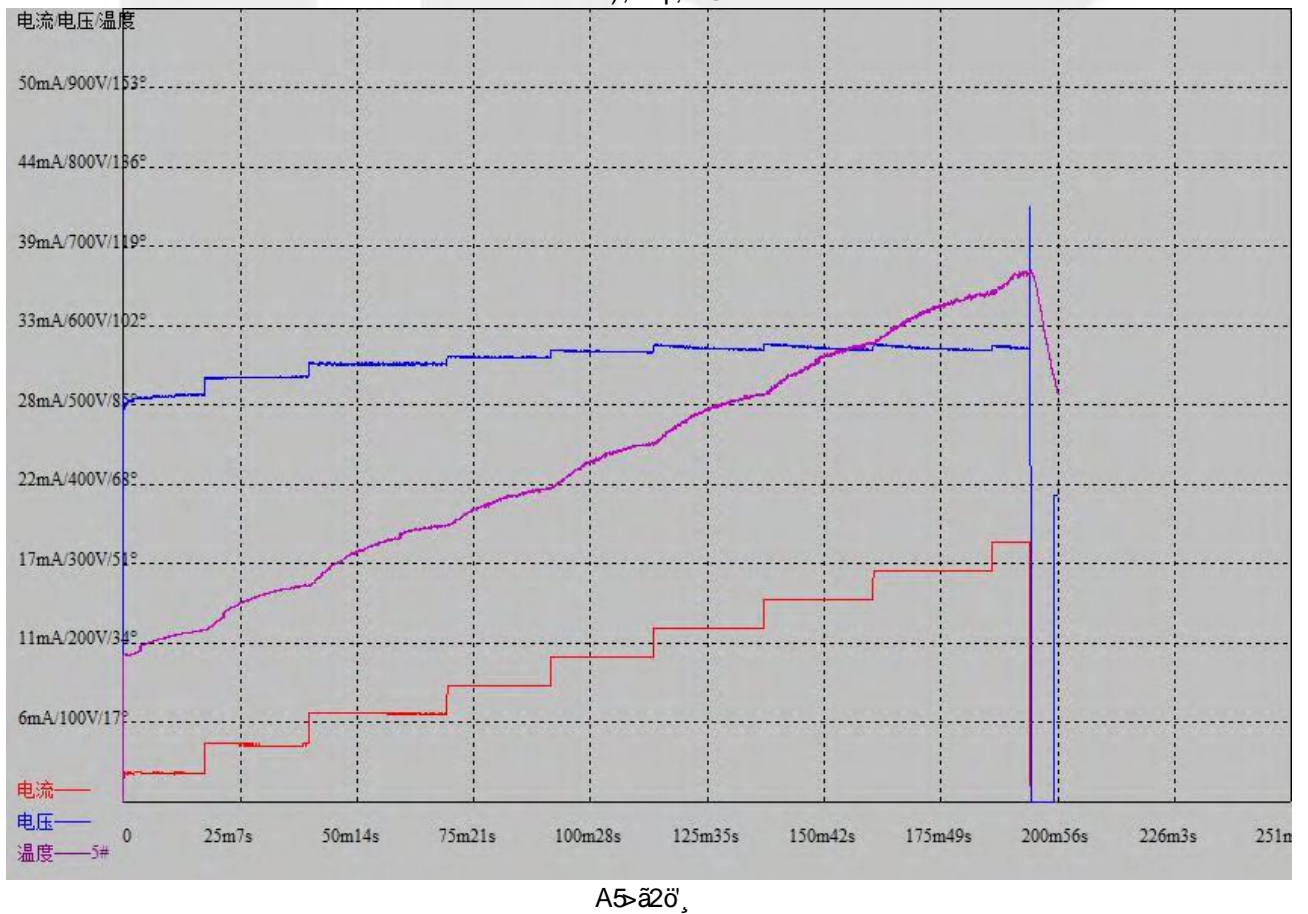

75) 1R* %7 %

+{ A .S A